



LoRa Measurement Report

Report #
6230117

Characterisation of
HRL-c-G3 BE Pulse

ordered by
Diehl Metering GmbH, Donaustr. 120, 90451 Nürnberg

performed at
IMST GMBH
LoRa Alliance Authorized Test House
Carl-Friedrich-Gauss-Str. 2-4
D-47475 Kamp-Lintfort
GERMANY

Contents

1. Preface	4
2. Administrative Summary	4
3. Measurement and Calibration Setup	5
3.1. Measurement Environment	5
3.2. Measurement Devices	6
3.3. Calibration Setup	7
3.3.1. Normalized Site Attenuation	7
3.3.2. LoRa Command and Tx/Rx Switch Box	8
3.4. Measurement Setup	9
3.4.1. Transmitter Performance Test Setup and Calibration Results	9
3.4.2. Receiver Performance Test Setup and Calibration Results	9
3.4.3. Transmitter Performance Power Sweep Setup	10
4. Measurement Results	11
4.1. Summary	11
4.2. Tx-Power for Channel: LOW	12
4.3. Tx-Power for Channel: MID	13
4.4. Tx-Power for Channel: HIGH	14
4.5. Tx-Power for Channel: HIGH (RX2)	15
4.6. Sensitivity for Channel: LOW-SF7BW125	16
4.7. Sensitivity for Channel: LOW-SF12BW125	17
4.8. Sensitivity for Channel: MID-SF7BW125	18
4.9. Sensitivity for Channel: MID-SF12BW125	19
4.10. Sensitivity for Channel: HIGH-SF7BW125	20
4.11. Sensitivity for Channel: HIGH-SF12BW125	21
4.12. Sensitivity for Channel: HIGH (RX2)-SF7BW125	22
4.13. Sensitivity for Channel: HIGH (RX2)-SF12BW125	23
Appendix A. Abbreviations	24

List of Figures

3.1. IMST Anechoic Chamber (Range II) B83117-A1431-T161	5
3.2. Calibration Setup	7
3.3. LoRa Command and Tx/Rx Switch Box	8
3.4. LoRa Measurement Setup	10
4.1. Tx Power Measurement Results for Channel: LOW	12
4.2. Tx Power Measurement Results for Channel: MID	13
4.3. Tx Power Measurement Results for Channel: HIGH	14
4.4. Tx Power Measurement Results for Channel: HIGH (RX2)	15
4.5. Rx Sensitivity Results for Channel: LOW-SF7BW125	16
4.6. Rx Sensitivity Results for Channel: LOW-SF12BW125	17
4.7. Rx Sensitivity Results for Channel: MID-SF7BW125	18
4.8. Rx Sensitivity Results for Channel: MID-SF12BW125	19
4.9. Rx Sensitivity Results for Channel: HIGH-SF7BW125	20
4.10. Rx Sensitivity Results for Channel: HIGH-SF12BW125	21
4.11. Rx Sensitivity Results for Channel: HIGH (RX2)-SF7BW125	22
4.12. Rx Sensitivity Results for Channel: HIGH (RX2)-SF12BW125	23

List of Tables

3.1. Devices used for calibration and measurement	6
3.2. Normalized Site Attenuation for Transmitter Performance Measurement	9
4.1. Tx Power Measurement Result Summary	11
4.2. Rx Sensitivity Result Summary	11
4.3. Tx Power Sweep Result	11

1. Preface

The objective of the investigations was to perform Radio Performance tests of the device **HRL-c-G3 BE Pulse** for the customer **Diehl Metering GmbH, Donastr. 120, 90451 Nürnberg** in accordance to the relevant requirements from the latest End-Device Certification Radiated RF Performance Specification for EU 868 MHz ISM Band Devices. The measurements described in this report cover all tests necessary for the device.

The test results only relate to the items tested. This report shall not be reproduced except in full without the written approval of the IMST GmbH.

2. Administrative Summary

Location: IMST GmbH, Test Centre, Kamp-Lintfort, Germany

Responsible Test Engineer: Yavuz Turan, Jens Lerner

Subject: Test of Radio Performance against RF Performance Specification for EU 868 MHz ISM Band Devices

Customer and Contact Information: Diehl Metering GmbH, Donastr. 120, 90451 Nürnberg

Tested Device: HRL-c-G3 BE Pulse

Measurement Date: 28.03.2023

Firmware Version: V4.1

Hardware Version: V1.0

End-device Identifier: 90dff818737f11d

LoRa Device Class: A

LoRaWAN Specification Version: V1.0.4

Certification Requirements: LoRaWAN End-Device RF Performance measurements for All Regions V1.0

Frequency Band(s) tested: 863.1 MHz, 865.1 MHz, 868.3 MHz, 869.525 MHz

Signatures:



Yavuz Turan
(Test Engineer)



Jens Lerner
(Quality Engineer)

3. Measurement and Calibration Setup

3.1. Measurement Environment

The measurements have been performed in the air conditioned and completely shielded anechoic chamber (Range II) B83117-A1431-T161 of IMST GmbH. This minimizes measurement errors caused by variations in temperature, disturbing signals and reflections. Movement of the DUT has been done by a "Roll over Azimuth" positioner. The mast that carries the roll axis is made from Kevlar. The accuracy of the azimuth positioner is 0.03° . During measurement the azimuth positioner is covered with absorbers. The distance between the measurement antenna and the rotation centre of the DUT was ca. 2.23 m during measurement (far field conditions).



Figure 3.1: IMST Anechoic Chamber (Range II) B83117-A1431-T161

3.2. Measurement Devices

All calibrations and measurements have been done with the devices that are stated in the following table. The date of the last calibration is shown in the column "Cal. Date".

Type & Manufacturer	Device	Ser. No.	Cal. Date
Spectrum Analyser Rhode & Schwarz	ZVL (9 kHz - 13.6 GHz)	101114	Aug. 2020
Network Analyser Agilent Technologies	E8363B (10 MHz - 40 GHz)	MY43030308	Jul. 2019
Signal Generator Hewlett Packard	83732A (50 MHz - 20 GHz)	3233A00127	Jul. 2019
Dual Ridged Horn (Measurement) Satimo	SH800 (0.8 - 12 GHz)	0077	Aug. 2019
Dual Ridged Horn (Measurement) Satimo	SH800 (0.8 - 12 GHz)	0078	Aug. 2019
Dual Ridged Horn (Reference) Satimo	SH800 (0.8 - 12 GHz)	00157	Aug. 2019
Anechoic chamber Siemens Matsushita	B83117-A1431-T161	Proj. No. 007-A34-089/99A	N/A
Roll/Azimuth positioner ORBIT/FR	AL-DBDR-3G/AL-560	434	N/A
Controller ORBIT/FR	AL-4164-MC	25	N/A
Control and measurement software IMST	Daric 2.0	N/A	N/A
Rohacell Bracket	Free space mounting	N/A	N/A
LoRa Gateway Semtech	IOT SX1301 Software Version: 3.1.0	N/A	N/A
USB Programmable Step Attenuator Mini-Circuits	Rudat-6000-90 (0 - 90 dB, 0.25 dB step)	11512160027	N/A
USB Programmable RF Switch IMST	4 x 2 way RF-Switch	N/A	N/A

Table 3.1: Devices used for calibration and measurement

3.3. Calibration Setup

3.3.1. Normalized Site Attenuation

The distance between calibration and measurement antenna is ca. 2.23 m. The S_{21} of the measurement range has been measured with a calibrated network analyser. The network analyser was SOLT calibrated between Port 1 and Port 2. The normalized site attenuation (NSA) which was present during the measurement was evaluated with the following formula:

$$D_{NSA} = S_{21} - G_{\text{gain ref. ant}} \quad (1)$$

Figure 3.2 shows the calibration setup in a simplified drawing. The reference antenna is a so called "well known device" (cf. table 3.1).

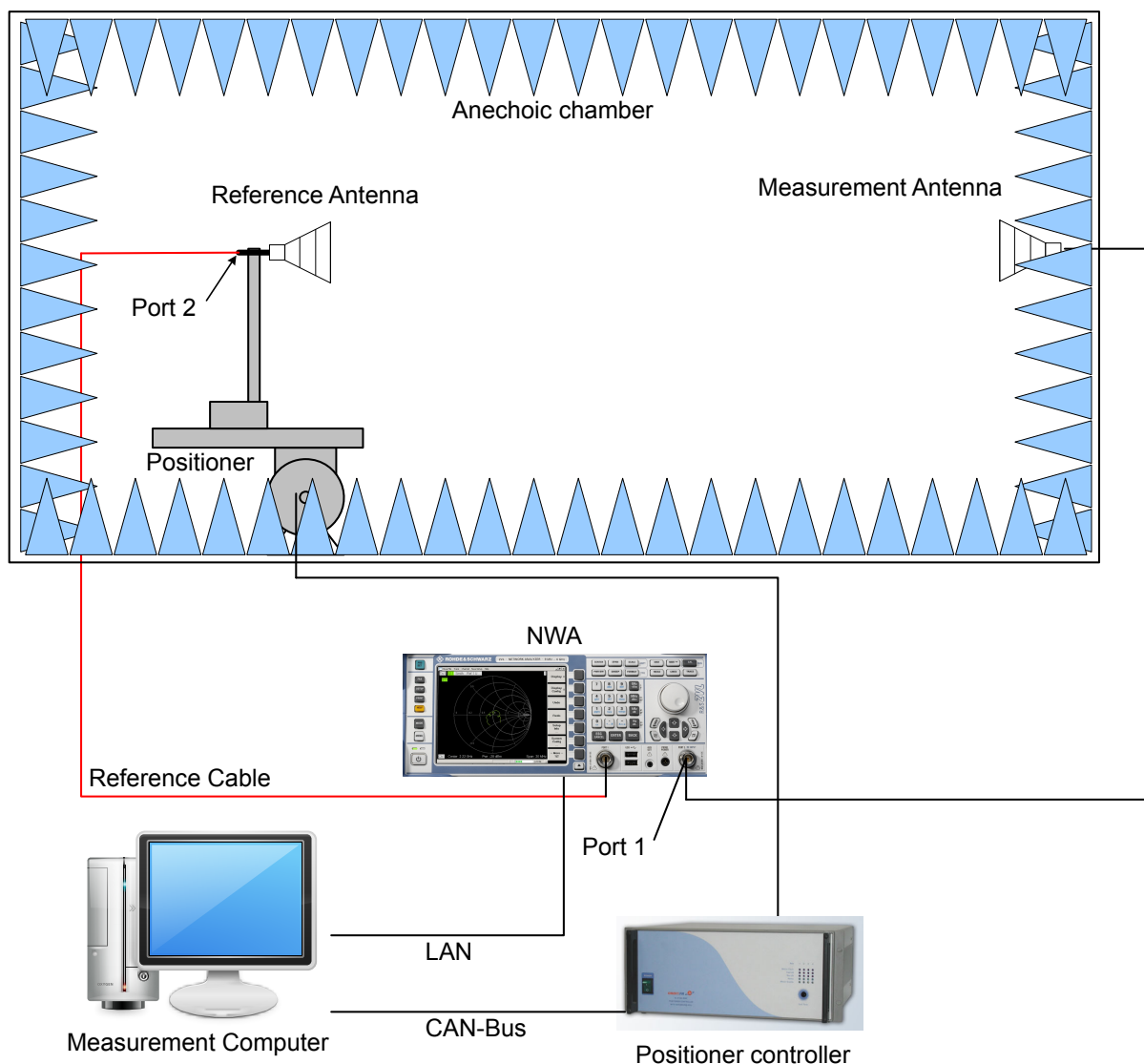

Figure 3.2: Calibration Setup

3.3.2. LoRa Command and Tx/Rx Switch Box

The LoRa Command and Tx/Rx Switch Box is used to switch between transmission (Tx) and receiver (Rx) performance measurement (cf. figure 3.3).

For the transmitter performance test the switch box is placed in the RF path between the Spectrum Analyser and port 1 as shown in figure 3.2. Therefore the insertion loss [$D_{\text{switch box}}$, red path in figure 3(b)] needs to be determined for calibration by using the spectrum analyser and a calibrated signal generator. A CW signal is generated with a known RF power (usually 0 dBm) and recorded as the insertion loss by the spectrum analyser. The final path loss can thus calculated to be:

$$D_{\text{tx path loss}} = D_{\text{NSA}} + D_{\text{switch box}} \quad (2)$$

For the receiver performance measurement calibration, the builtin LoRa Gateway [cf. figure 3(b)] is set to transmit a CW signal and the spectrum analyser is used to record both the output power toward the measurement antenna (red path) with the step attenuator set to zero ($D_{\text{step attenuator}} = 0$ dB) and the spectrum analyser measurement path (blue path). The difference ($D_{\text{GW ref power}}$) is recorded and can be used to determine the RF receiver power at the DUT as follows:

$$P_{\text{DUT}} = P_{\text{measured}} + D_{\text{GW ref power}} - D_{\text{NSA}} - D_{\text{step attenuator}} \quad (3)$$

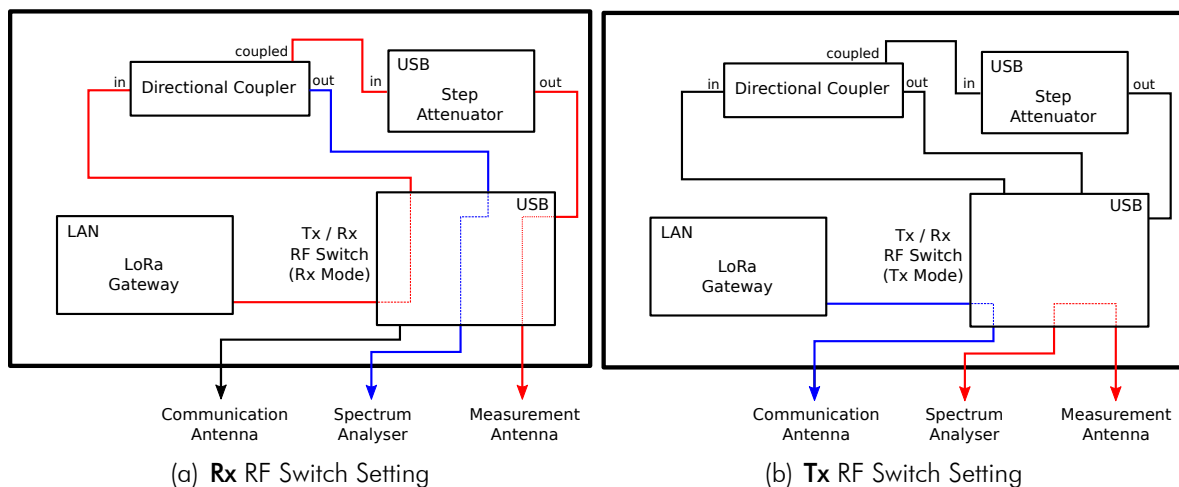

Figure 3.3: LoRa Command and Tx/Rx Switch Box

3.4. Measurement Setup

3.4.1. Transmitter Performance Test Setup and Calibration Results

The continuous wave mode for a specific uplink (UL) frequency is enabled by the measurement software. The EIRP has been measured as a full 3D radiation power pattern with a grid segmentation on the sphere of 15.0° in azimuth (theta, Θ) and 15.0° in roll (phi, Φ) direction.

This has been done with two polarizations (E_Θ and E_Φ) of the measurement antenna and the LoRa Switch Box set to Tx configuration. Details for the LoRa Switch Box are depicted in figure 3(b). Figure 3.4 shows the measurement setup in a simplified drawing. For all measurements the end device output power level was configured to 16 dBm. The insertion loss of the LoRa Switch Box in Tx configuration was calibrated to $D_{\text{switch box}} = 1.9$ dB. The normalized site attenuation (D_{NSA}) was calibrated for the different channels as shown in table 3.2.

Channel	Freq. (MHz)	Theta-Pol. (dB)	Phi-Pol. (dB)
LOW	863.1	35.3	35.5
MID	865.1	35.3	35.6
HIGH	868.3	35.4	35.6
HIGH (RX2)	869.5	35.4	35.6

Table 3.2: Normalized Site Attenuation for Transmitter Performance Measurement

The TRP/EIRP result summary can be found in table 4.1.

The TRP/EIRP uncertainty of the measurement has been specified with ± 1.5 dB.

3.4.2. Receiver Performance Test Setup and Calibration Results

The effective isotropic sensitivity (EIS) was measured for each channel at a single point in the direction of the maximum EIRP. The end device receiver performance was measured with a measurement setup as depicted in figure 3.4. For this test the LoRa Switch Box is set to Rx configuration [cf. 3(a)] and the packet error rate (PER) limit of 10% was determined with 60 packets sent from the gateway. The gateway reference power difference was calibrated to $D_{\text{GW ref power}} = -25.4$ dB. The normalized site attenuation (D_{NSA}) was calibrated for the different channels (MID for RX1 and HIGH for RX2) as shown in table 3.2.

The TIS/EIS result summary can be found in table 4.2.

The TIS/EIS uncertainty of the measurement has been specified with ± 2 dB.

3.4.3. Transmitter Performance Power Sweep Setup

For the transmitter performance power sweep the EIRP was measured for each channel at a single point in the direction of the maximum EIRP as measured in the full 3D reference measurement (cf. chapter 3.4.1) The resulting EIRP for all available Tx power settings and channels was used to calculate the total radiated power (TRP) for the respective channels and settings.

The TRP power sweep result summary can be found in table 4.3.

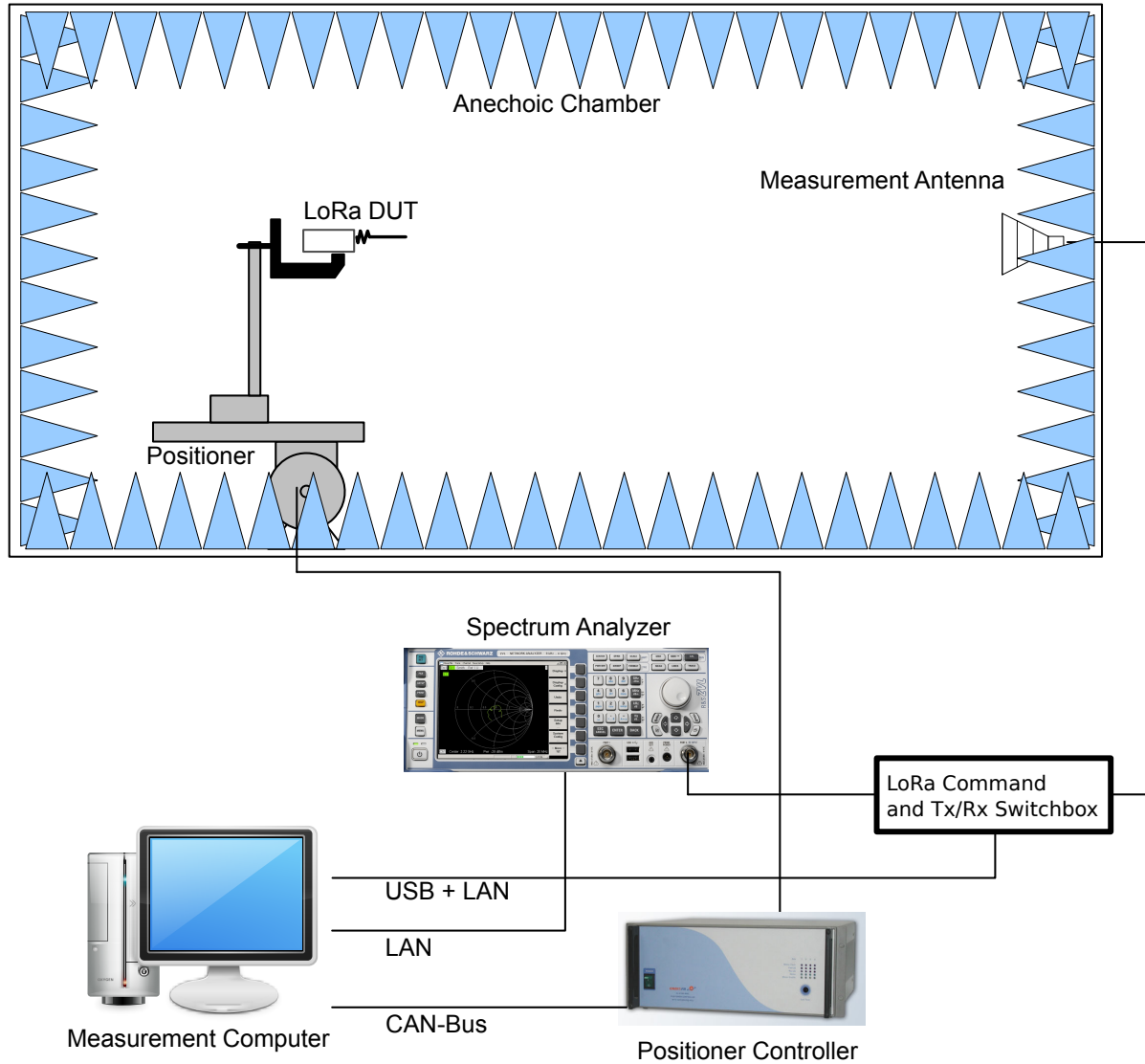

Figure 3.4: LoRa Measurement Setup

4. Measurement Results

4.1. Summary

Channel	max. EIRP (dBm)			TRP (dBm)
	$P(E^\ominus)$	$P(E^\Phi)$	$P(E)$	
LOW	13.5	12.9	13.9	11.5
MID	13.5	12.9	14.0	11.5
HIGH	13.5	13.0	14.0	11.5
HIGH (RX2)	13.4	13.0	14.0	11.5

Table 4.1: Tx Power Measurement Result Summary

Channel	max. EIS (dBm)			TIS (dBm)
	S^\ominus	S^Φ	S^{eff}	
LOW-SF7BW125	-122.8	-122.2	-123.2	-120.8
LOW-SF12BW125	-133.8	-133.2	-134.3	-131.8
MID-SF7BW125	-122.8	-122.2	-123.3	-120.9
MID-SF12BW125	-136.3	-135.7	-136.7	-134.3
HIGH-SF7BW125	-123.5	-123.0	-124.0	-121.5
HIGH-SF12BW125	-134.4	-133.9	-135.0	-132.4
HIGH (RX2)-SF7BW125	-123.5	-123.1	-124.2	-121.6
HIGH (RX2)-SF12BW125	-137.0	-136.6	-137.6	-135.1

Table 4.2: Rx Sensitivity Result Summary

Channel	max. EIRP (dBm)						
	2.0	5.0	8.0	11.0	14.0	16.0	20.0
LOW	3.0	6.4	9.7	12.3	13.5	13.5	13.5
MID	3.1	6.4	9.7	12.3	13.5	13.5	13.5
HIGH	3.1	6.4	9.7	12.3	13.5	13.5	13.5
HIGH (RX2)	3.0	6.3	9.6	12.2	13.4	13.4	13.4

Table 4.3: Tx Power Sweep Result

4.2. Tx-Power for Channel: LOW

UL-Frequency: 863100000 Hz
 TRP: 11.5 dBm
 max. EIRP (Θ): 13.5 dBm at ($\Theta=165.0^\circ, \Phi=240.0^\circ$)
 max. EIRP (Φ): 12.9 dBm at ($\Theta=105.0^\circ, \Phi=330.0^\circ$)
 max. EIRP (abs): 13.9 dBm at ($\Theta=120.0^\circ, \Phi=330.0^\circ$)

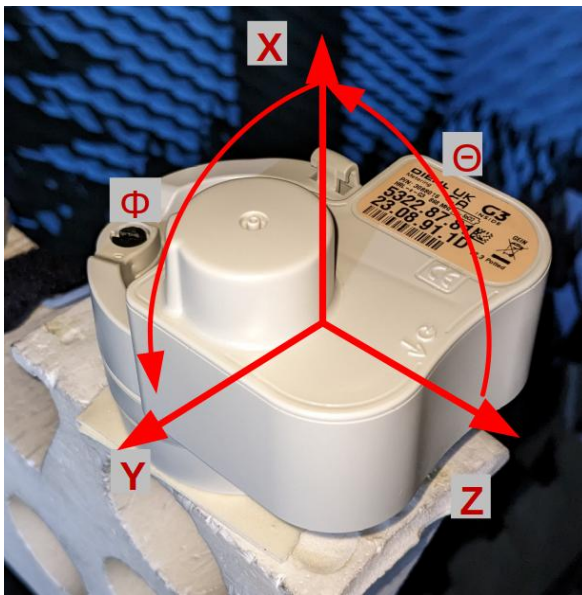

(a) Device under Test

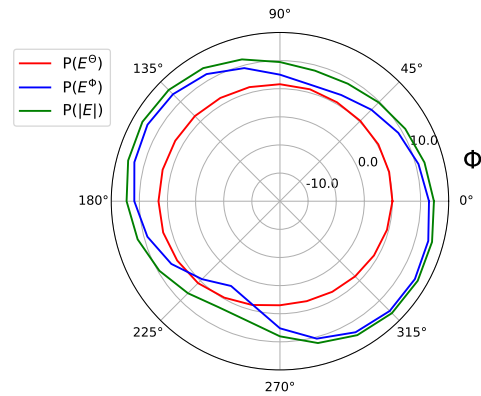

(b) xy-plane

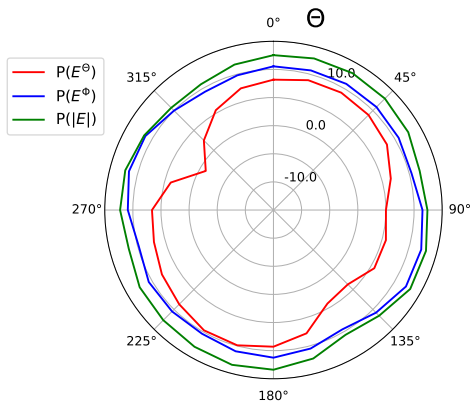

(c) xz-plane

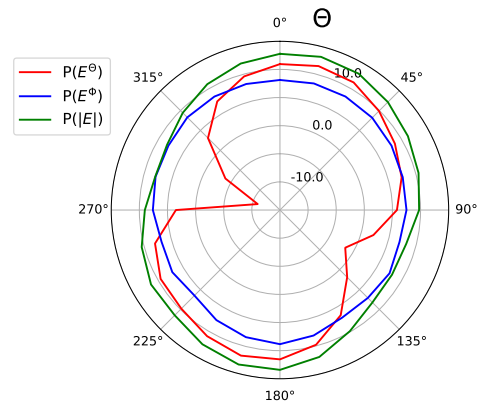

(d) yz-plane

Figure 4.1: Tx Power Measurement Results for Channel: LOW

4.3. Tx-Power for Channel: MID

UL-Frequency: 865100110 Hz
TRP: 11.5 dBm
max. EIRP (Θ): 13.5 dBm at ($\Theta=165.0^\circ, \Phi=240.0^\circ$)
max. EIRP (Φ): 12.9 dBm at ($\Theta=105.0^\circ, \Phi=330.0^\circ$)
max. EIRP (abs): 14.0 dBm at ($\Theta=120.0^\circ, \Phi=330.0^\circ$)

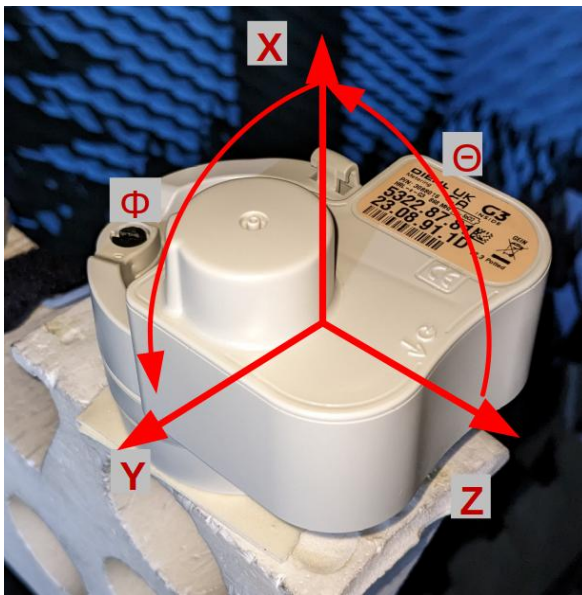

(a) Device under Test

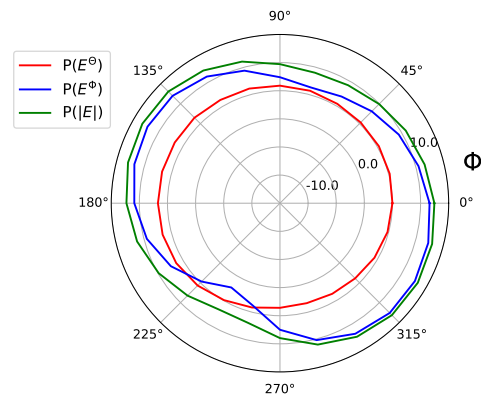

(b) xy-plane

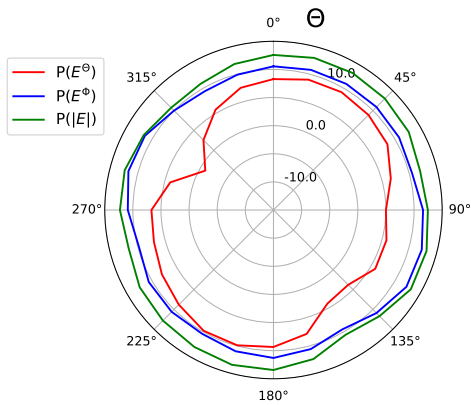

(c) xz-plane

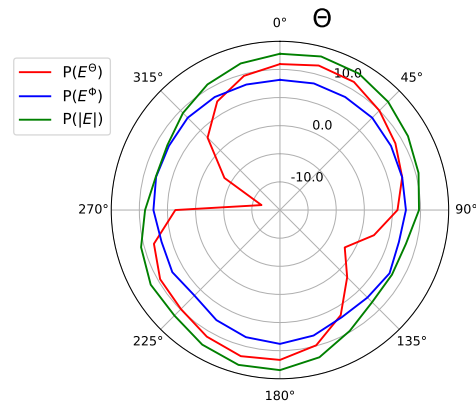

(d) yz-plane

Figure 4.2: Tx Power Measurement Results for Channel: MID

4.4. Tx-Power for Channel: HIGH

UL-Frequency: 868300220 Hz
TRP: 11.5 dBm
max. EIRP (Θ): 13.5 dBm at ($\Theta=165.0^\circ, \Phi=240.0^\circ$)
max. EIRP (Φ): 13.0 dBm at ($\Theta=105.0^\circ, \Phi=330.0^\circ$)
max. EIRP (abs): 14.0 dBm at ($\Theta=120.0^\circ, \Phi=330.0^\circ$)

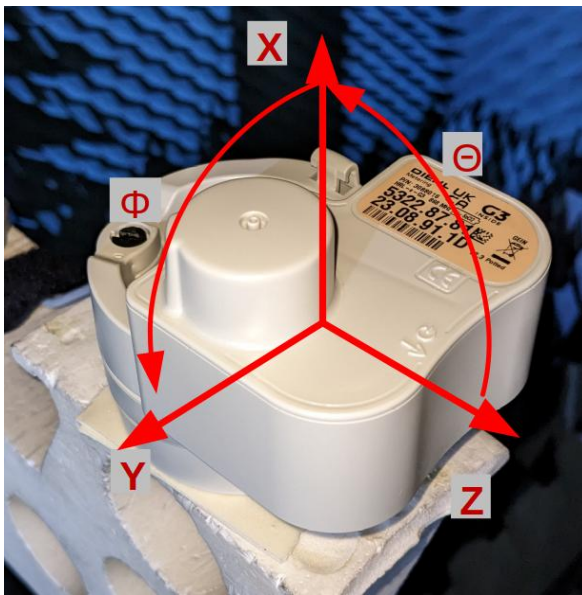

(a) Device under Test

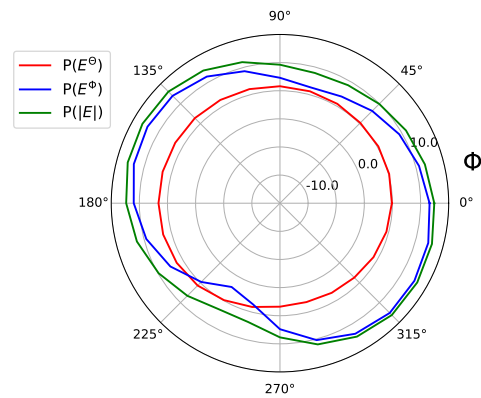

(b) xy-plane

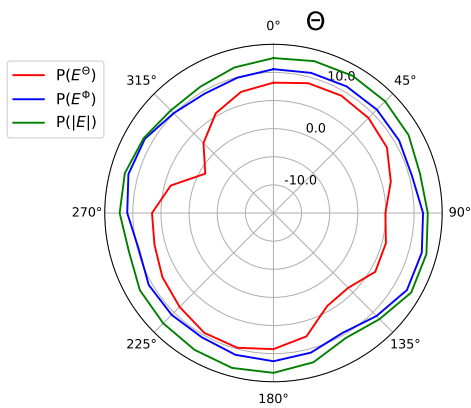

(c) xz-plane

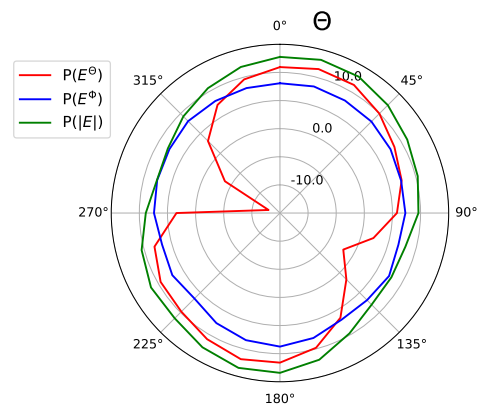

(d) yz-plane

Figure 4.3: Tx Power Measurement Results for Channel: HIGH

4.5. Tx-Power for Channel: HIGH (RX2)

UL-Frequency: 869525220 Hz
TRP: 11.5 dBm
max. EIRP (Θ): 13.4 dBm at ($\Theta=165.0^\circ, \Phi=240.0^\circ$)
max. EIRP (Φ): 13.0 dBm at ($\Theta=105.0^\circ, \Phi=330.0^\circ$)
max. EIRP (abs): 14.0 dBm at ($\Theta=120.0^\circ, \Phi=330.0^\circ$)

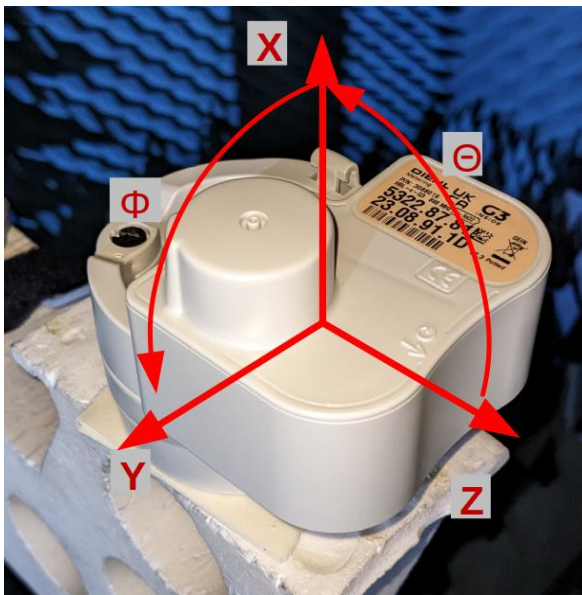

(a) Device under Test

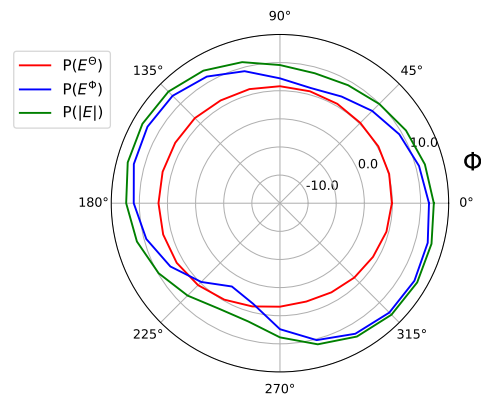

(b) xy-plane

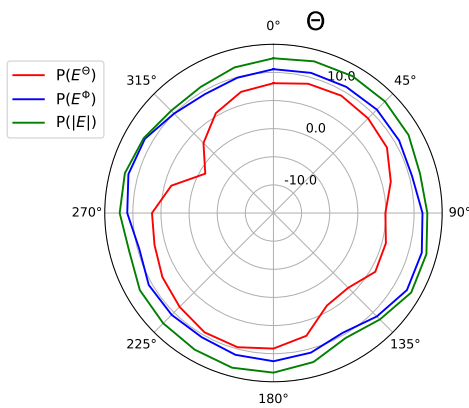

(c) xz-plane

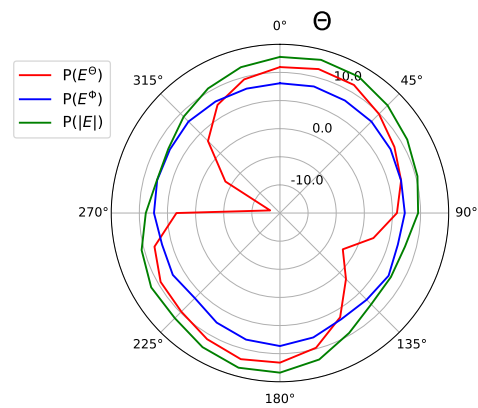

(d) yz-plane

Figure 4.4: Tx Power Measurement Results for Channel: HIGH (RX2)

4.6. Sensitivity for Channel: LOW-SF7BW125

DL-Frequency: 863100000 Hz
 TIS: -120.8 dBm
 max. EIS (Θ): -122.8 dBm at ($\Theta=165.0^\circ, \Phi=240.0^\circ$)
 max. EIS (Φ): -122.2 dBm at ($\Theta=105.0^\circ, \Phi=330.0^\circ$)
 max. EIS (eff.): -123.2 dBm at ($\Theta=120.0^\circ, \Phi=330.0^\circ$)

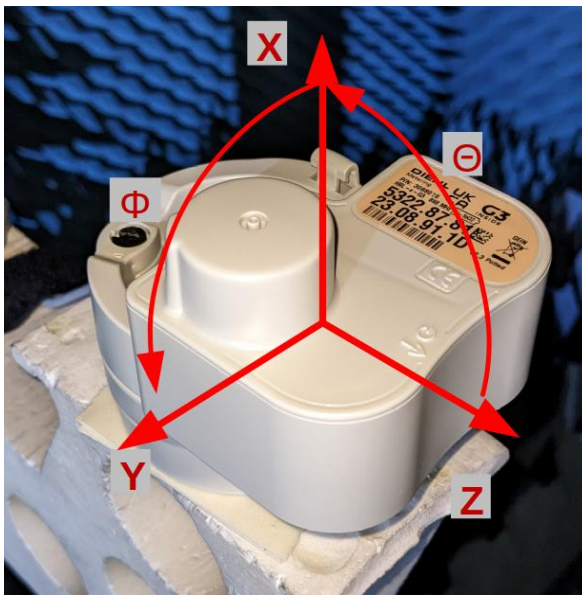

(a) Device under Test

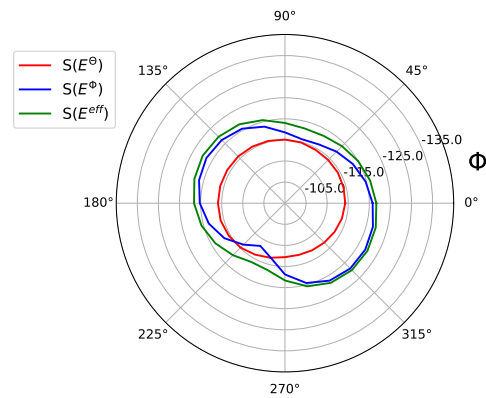

(b) xy-plane

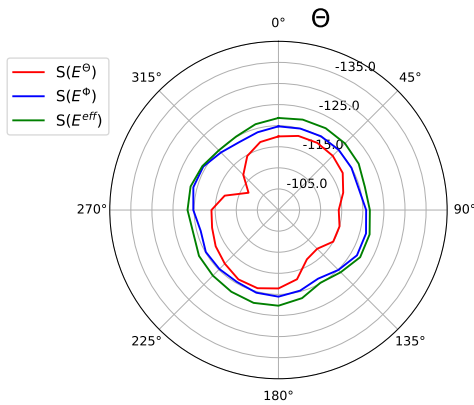

(c) xz-plane

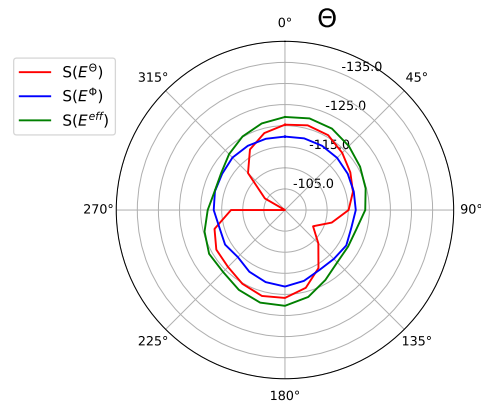

(d) yz-plane

Figure 4.5: Rx Sensitivity Results for Channel: LOW-SF7BW125

4.7. Sensitivity for Channel: LOW-SF12BW125

DL-Frequency: 863100000 Hz
 TIS: -131.8 dBm
 max. EIS (Θ): -133.8 dBm at ($\Theta=165.0^\circ, \Phi=240.0^\circ$)
 max. EIS (Φ): -133.2 dBm at ($\Theta=105.0^\circ, \Phi=330.0^\circ$)
 max. EIS (eff.): -134.3 dBm at ($\Theta=120.0^\circ, \Phi=330.0^\circ$)

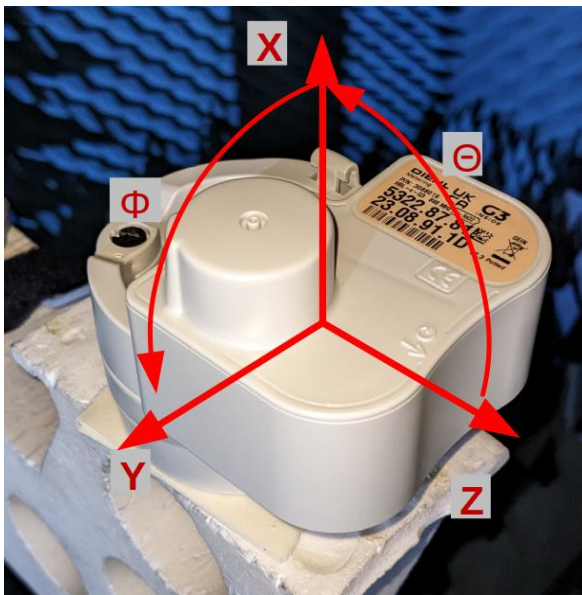

(a) Device under Test

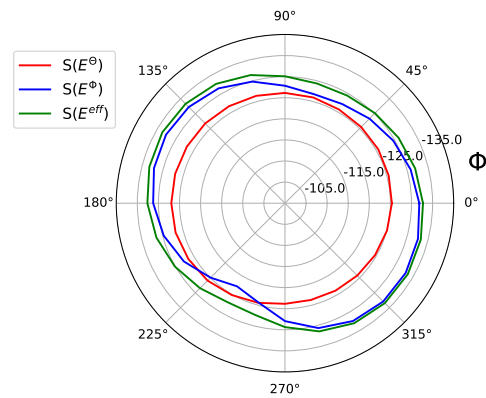

(b) xy-plane

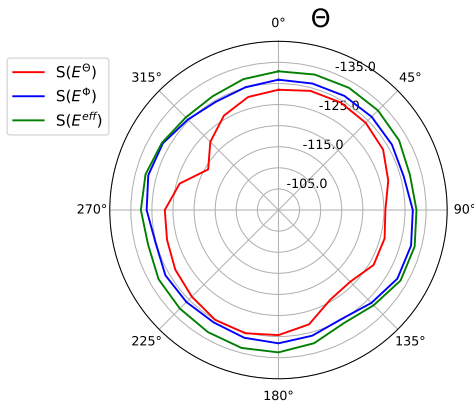

(c) xz-plane

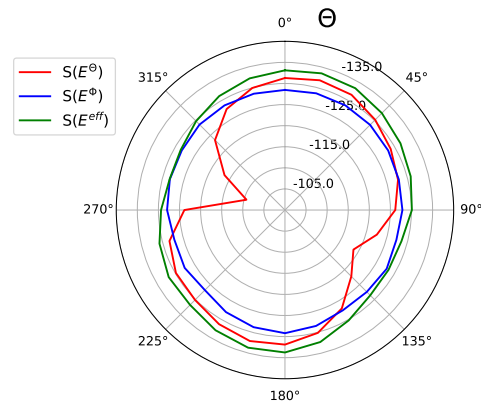

(d) yz-plane

Figure 4.6: Rx Sensitivity Results for Channel: LOW-SF12BW125

4.8. Sensitivity for Channel: MID-SF7BW125

DL-Frequency: 865100110 Hz
 TIS: -120.9 dBm
 max. EIS (Θ): -122.8 dBm at ($\Theta=165.0^\circ, \Phi=240.0^\circ$)
 max. EIS (Φ): -122.2 dBm at ($\Theta=105.0^\circ, \Phi=330.0^\circ$)
 max. EIS (eff.): -123.3 dBm at ($\Theta=120.0^\circ, \Phi=330.0^\circ$)

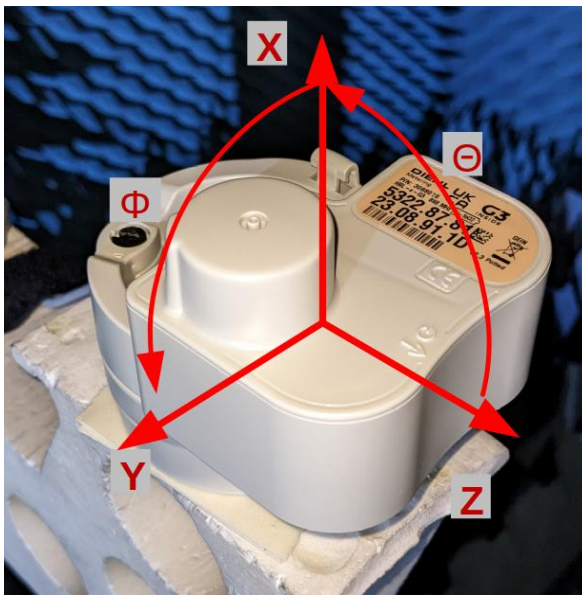

(a) Device under Test

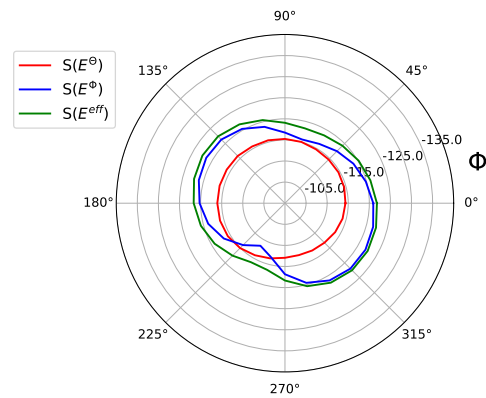

(b) xy-plane

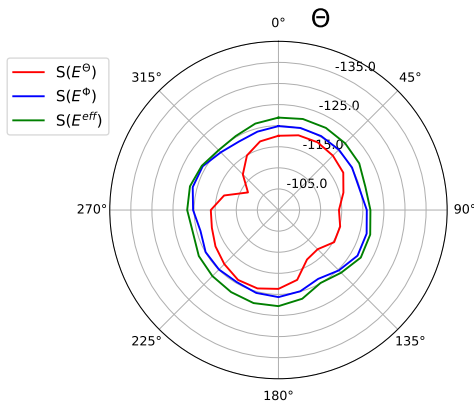

(c) xz-plane

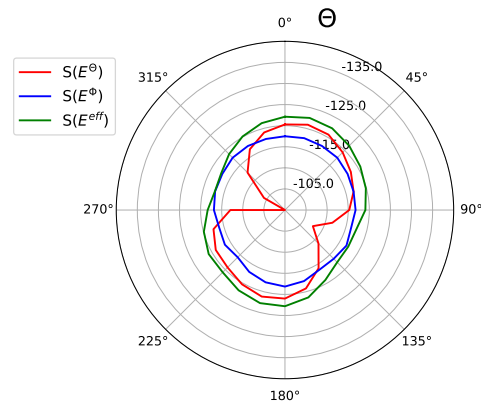

(d) yz-plane

Figure 4.7: Rx Sensitivity Results for Channel: MID-SF7BW125

4.9. Sensitivity for Channel: MID-SF12BW125

DL-Frequency: 865100110 Hz
 TIS: -134.3 dBm
 max. EIS (Θ): -136.3 dBm at ($\Theta=165.0^\circ, \Phi=240.0^\circ$)
 max. EIS (Φ): -135.7 dBm at ($\Theta=105.0^\circ, \Phi=330.0^\circ$)
 max. EIS (eff.): -136.7 dBm at ($\Theta=120.0^\circ, \Phi=330.0^\circ$)

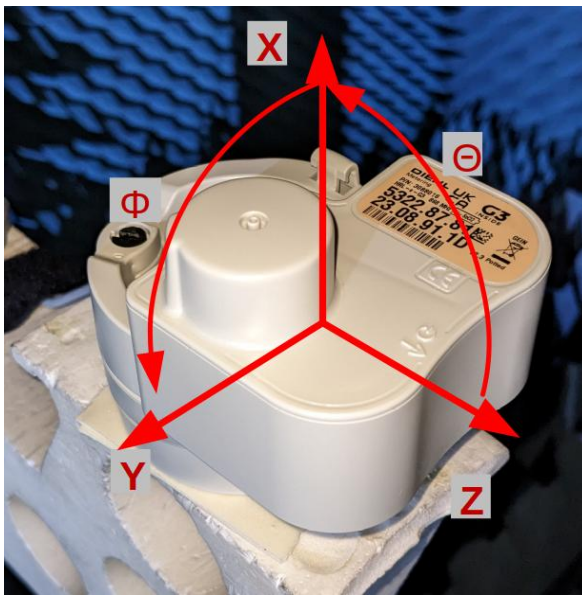

(a) Device under Test

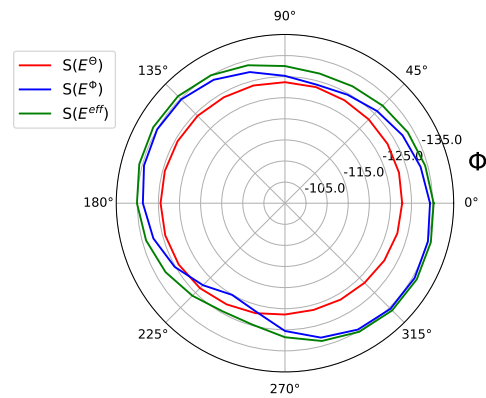

(b) xy-plane

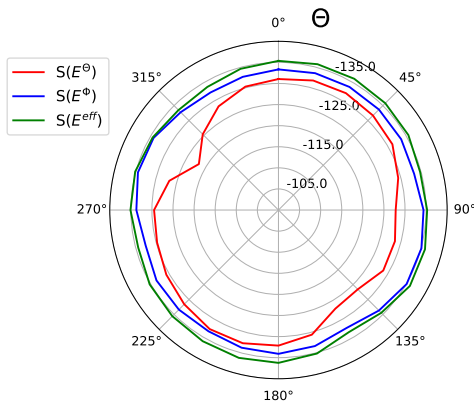

(c) xz-plane

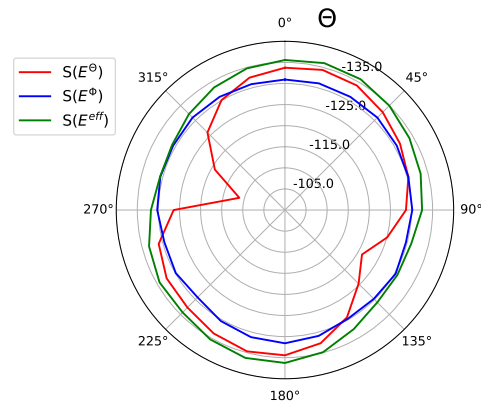

(d) yz-plane

Figure 4.8: Rx Sensitivity Results for Channel: MID-SF12BW125

4.10. Sensitivity for Channel: HIGH-SF7BW125

DL-Frequency: 868300220 Hz
 TIS: -121.5 dBm
 max. EIS (Θ): -123.5 dBm at ($\Theta=165.0^\circ, \Phi=240.0^\circ$)
 max. EIS (Φ): -123.0 dBm at ($\Theta=105.0^\circ, \Phi=330.0^\circ$)
 max. EIS (eff.): -124.0 dBm at ($\Theta=120.0^\circ, \Phi=330.0^\circ$)

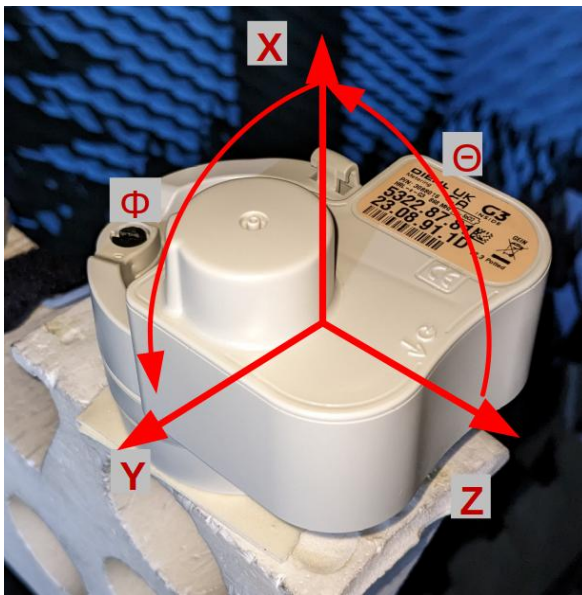

(a) Device under Test

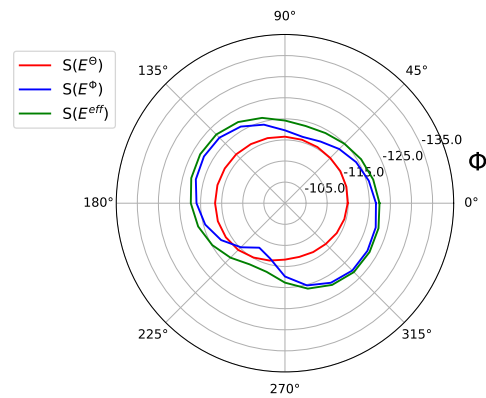

(b) xy-plane

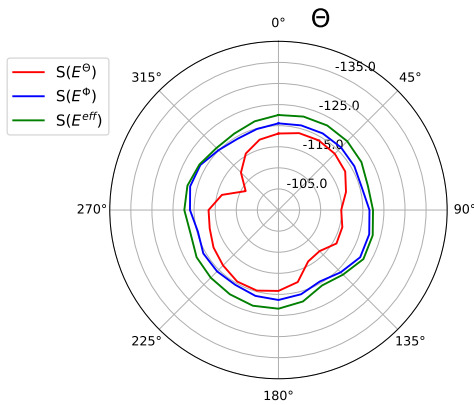

(c) xz-plane

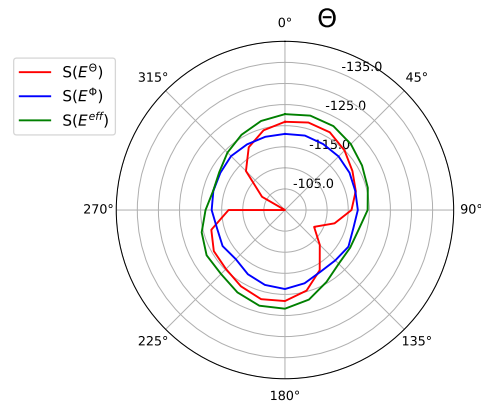

(d) yz-plane

Figure 4.9: Rx Sensitivity Results for Channel: HIGH-SF7BW125

4.11. Sensitivity for Channel: HIGH-SF12BW125

DL-Frequency: 868300220 Hz
 TIS: -132.4 dBm
 max. EIS (Θ): -134.4 dBm at ($\Theta=165.0^\circ, \Phi=240.0^\circ$)
 max. EIS (Φ): -133.9 dBm at ($\Theta=105.0^\circ, \Phi=330.0^\circ$)
 max. EIS (eff.): -135.0 dBm at ($\Theta=120.0^\circ, \Phi=330.0^\circ$)

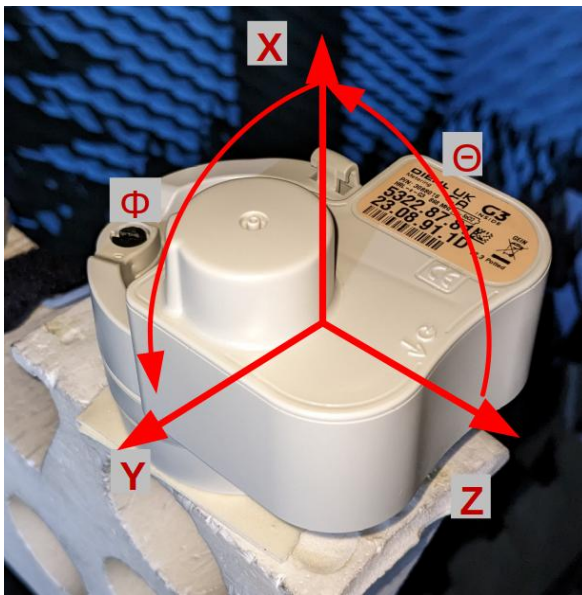

(a) Device under Test

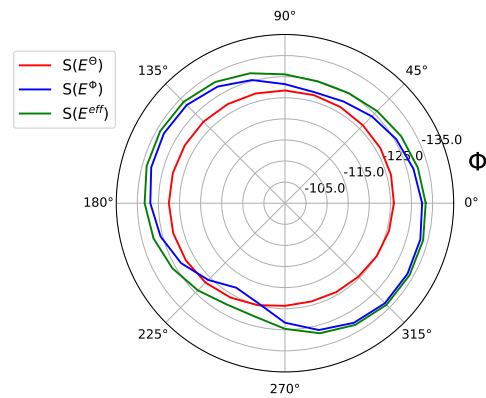

(b) xy-plane

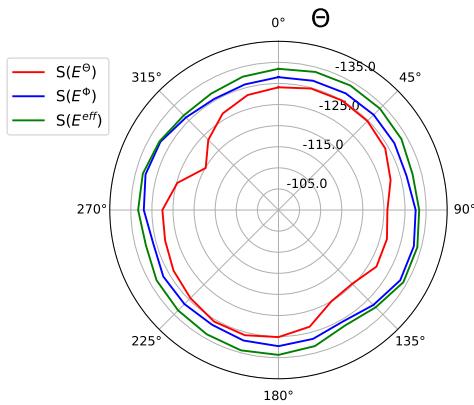

(c) xz-plane

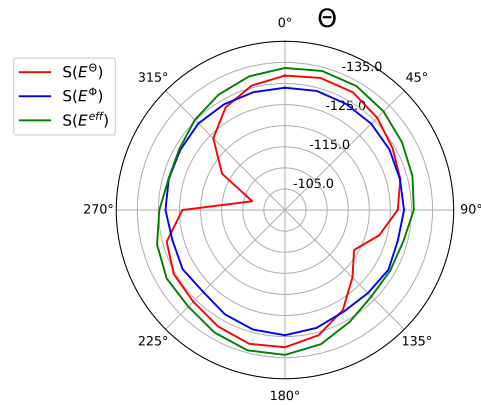

(d) yz-plane

Figure 4.10: Rx Sensitivity Results for Channel: HIGH-SF12BW125

4.12. Sensitivity for Channel: HIGH (RX2)-SF7BW125

DL-Frequency: 869525220 Hz
 TIS: -121.6 dBm
 max. EIS (Θ): -123.5 dBm at ($\Theta=165.0^\circ, \Phi=240.0^\circ$)
 max. EIS (Φ): -123.1 dBm at ($\Theta=105.0^\circ, \Phi=330.0^\circ$)
 max. EIS (eff.): -124.2 dBm at ($\Theta=120.0^\circ, \Phi=330.0^\circ$)

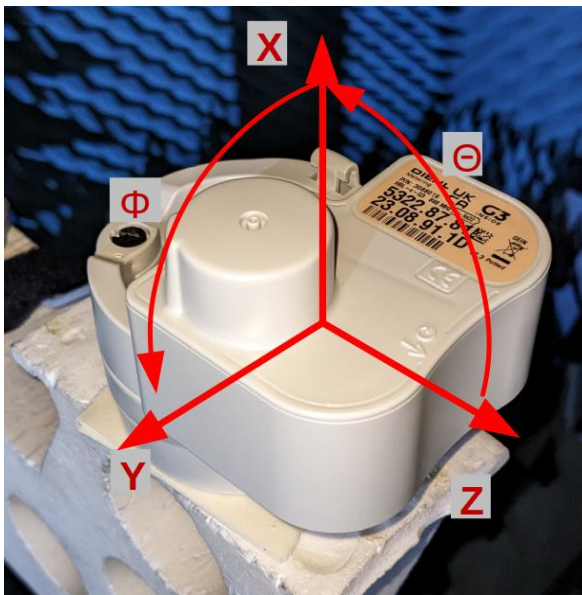

(a) Device under Test

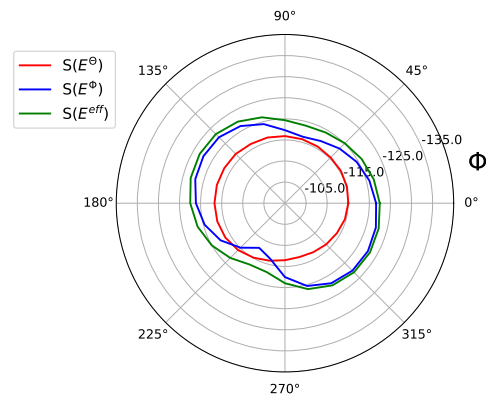

(b) xy-plane

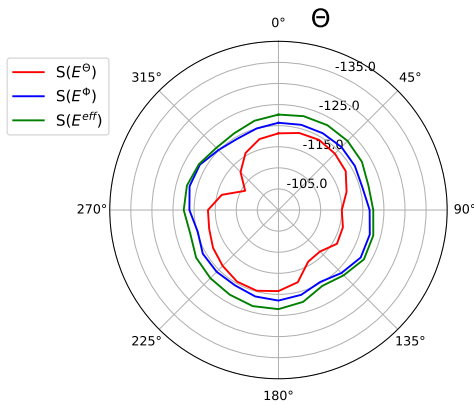

(c) xz-plane

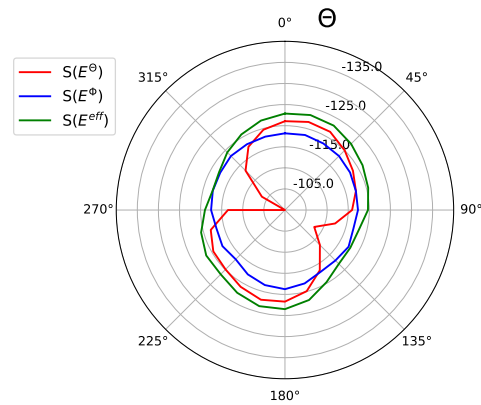

(d) yz-plane

Figure 4.11: Rx Sensitivity Results for Channel: HIGH (RX2)-SF7BW125

4.13. Sensitivity for Channel: HIGH (RX2)-SF12BW125

DL-Frequency: 869525220 Hz
 TIS: -135.1 dBm
 max. EIS (Θ): -137.0 dBm at ($\Theta=165.0^\circ, \Phi=240.0^\circ$)
 max. EIS (Φ): -136.6 dBm at ($\Theta=105.0^\circ, \Phi=330.0^\circ$)
 max. EIS (eff.): -137.6 dBm at ($\Theta=120.0^\circ, \Phi=330.0^\circ$)

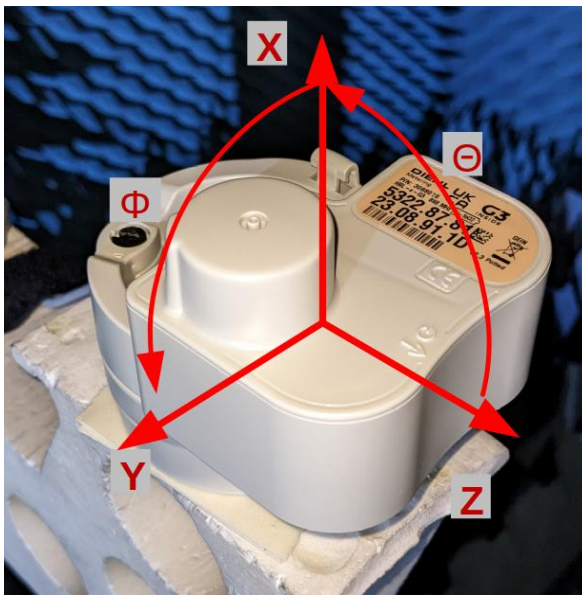

(a) Device under Test

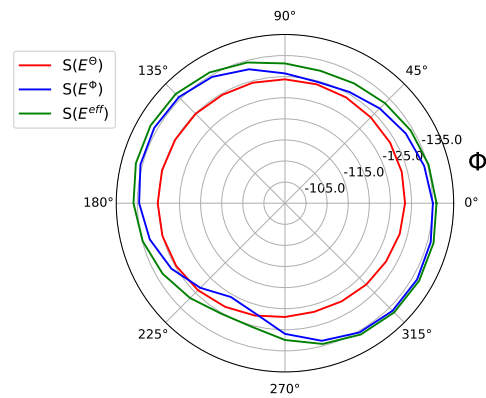

(b) xy-plane

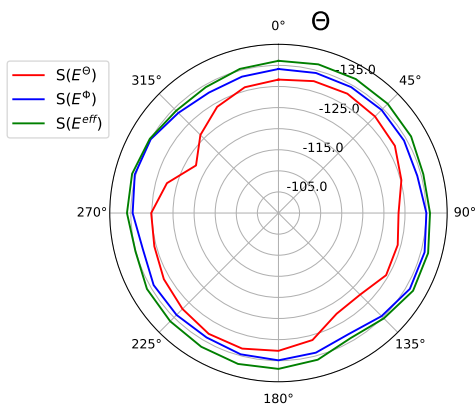

(c) xz-plane

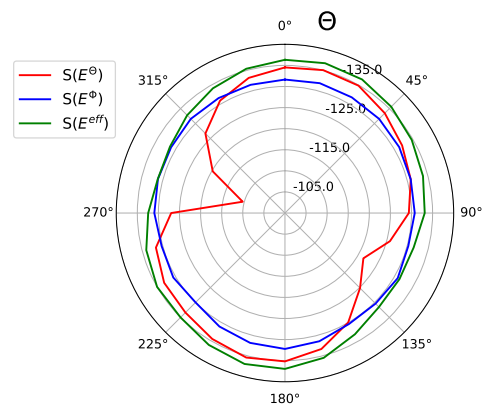

(d) yz-plane

Figure 4.12: Rx Sensitivity Results for Channel: HIGH (RX2)-SF12BW125

A. Abbreviations

EIRP	Equivalent Isotropic Radiated Power
EIS	Equivalent Isotropic Sensitivity
TRP	Total Radiated Power
TIS	Total Isotropic Sensitivity
CW	Continuous Wave
NSA	Normalized Site Attenuation
RF	Radio Frequency
Rx	Receiver (Mode)
Tx	Transmitter (Mode)
UL	Uplink
DL	Downlink
SF	Spreading Factor
BW	Bandwidth