

LoRa accredited Test Lab



Test report No:

NIE: 68029RAN.001

Test report

LoRaWAN End-Device RF Performance measurements for All Regions

(*) Identification of item tested	G2-IPS-CLW
(*) Trademark	G2
(*) Model and /or type reference	G2-IPS-CLW
(*) Other identification of the product	HW version: 1.5 SW version: 1.94k
(*) Features	LoRaWan 868MHz
(*) Manufacturer	G2 MISURATORI SRL VIA SAN MARTINO 38-14100 ASTI (AT)- ITALY
Test method requested, standard	[1] LoRaWAN End-Device RF Performance measurements for All Regions
Approved by (name / position & signature)	Miguel Lacave Antennas Lab. Manager
Date of issue	2021-03-30
Report template No	FDT08_22 (* "Data provided by the client")

Index

Competences and guarantees	3
General conditions	3
Uncertainty	3
Data provided by the client.....	3
Usage of samples	4
Test sample description	4
Identification of the client.....	4
Testing period and place.....	4
Document history	4
Environmental conditions	5
Remarks and comments	5
Testing verdicts.....	6
Summary	6
Appendix A: Test results	7
Appendix B: Photographs	33

Competences and guarantees

DEKRA Testing and Certification, S.A.U. is a testing laboratory competent to carry out the tests described in this report.

In order to assure the traceability to other national and international laboratories, DEKRA Testing and Certification, S.A.U. has a calibration and maintenance program for its measurement equipment.

DEKRA Testing and Certification, S.A.U. guarantees the reliability of the data presented in this report, which is the result of the measurements and the tests performed to the item under test on the date and under the conditions stated on the report and, it is based on the knowledge and technical facilities available at DEKRA Testing and Certification, S.A.U. at the time of performance of the test.

DEKRA Testing and Certification, S.A.U. is liable to the client for the maintenance of the confidentiality of all information related to the item under test and the results of the test.

The results presented in this Test Report apply only to the particular item under test established in this document.

IMPORTANT: No parts of this report may be reproduced or quoted out of context, in any form or by any means, except in full, without the previous written permission of DEKRA Testing and Certification, S.A.U.

General conditions

1. This report is only referred to the item that has undergone the test.
2. This report does not constitute or imply on its own an approval of the product by the Certification Bodies or competent Authorities.
3. This document is only valid if complete; no partial reproduction can be made without previous written permission of DEKRA Testing and Certification, S.A.U.
4. This test report cannot be used partially or in full for publicity and/or promotional purposes without previous written permission of DEKRA Testing and Certification, S.A.U. and the Accreditation Bodies.

Uncertainty

Uncertainty (factor $k=2$) was calculated according to the following documents:

1. CTIA Test plan for mobile station over the air performance. Method of measurement for radiated RF power and receiver performance. April 2019. Revision 3.8.2.
2. FAN06 - OTA SISO CTIA - AMS-8700 Uncertainty report

Data provided by the client

The following data has been provided by the client:

1. Information relating to the description of the sample ("Identification of the item tested", "Trademark", "Model and/or type reference tested", "Other identification of the product", "Features", "Manufacturer" and "Test sample description").
2. Information in section "Test sample description"

DEKRA Testing and Certification, S.A.U. declines any responsibility with respect to the information provided by the client and that may affect the validity of results.

Usage of samples

Samples undergoing test have been selected by the client.

Sample M/01 is composed of the following elements:

Control Nº	Description	Model	S/N	Date of reception
68029/006	G2-IPS-CLW	G2-IPS-CLW	2102100028	2021-03-25
68029/010	G2-IPS-CLW	G2-IPS-CLW	2102100030	2021-03-29

1. Sample M/01 has undergone the test(s) specified in subclause "Test method requested".

Test sample description

The sample under tests consist of an ultrasonic water meter for residential households and apartments.

Identification of the client

Company name: G2 MISURATORI SRL

Postal address: VIA SAN MARTINO 38-14100 ASTI (AT)- ITALY

Contact person: ENRICA POGLIO

E-mail: enricapoglio@g2misuratori.it / info@g2misuratori.it

Telephone: +39 0141721787

Testing period and place

Test Location	DEKRA Testing and Certification S.A.U.
Date (start)	2021-03-25
Date (finish)	2021-03-30

Document history

Report number	Date	Description
68029RAN.001	2021-03-30	First release

Environmental conditions

Date	Max. Temp. °C	Min. Temp. °C	Max. Hum. %	Min. Hum. %
From 2021-03-25 to 2021-03-30	23.5	20.7	60.2	39.2

Remarks and comments

The instrumentation utilized to perform the tests covered in this test report is listed in the following table.

Equipment	Control N°
1. Anechoic chamber ETS LINDGREN AMS-8500	2729
2. Positioning system controller and RF switch Agilent Technologies 3499A	2831
3. OTA measurement software ETS LINDGREN EMQuest v1.13	4428
4. Spectrum analyzer Agilent Technologies PSA	2327
5. LoRa Gateway Semtech IOT868TKLM1 HAL v3.2.0	7213
6. Step attenuator Vaunix Technology Corporation Lab BrickDigital Attenuator	5409
7. RF Circulator Channel Microwave Corporation, Model BUL330	1151
8. RF Isolator Channel Microwave Corporation, Model AUL330	1152
9. Temperature and Pico Tehcnology, model Humidityprobe	3574

Testing has been performed by Francisco José Alcaide.

Testing verdicts

Not applicable	:	N/A
Pass.....	:	P
Fail	:	F
Measured	:	M
Not measured	:	N/M

Summary

Transmitter Performance:

LoRaWAN End-Device RF Performance measurements for All Regions	Verdict				
	N/A	P	F	M	N/M
2 : End-device transmitter performance				X	

Receiver Performance:

LoRaWAN End-Device RF Performance measurements for All Regions	Verdict				
	N/A	P	F	M	N/M
3 : End-device receiver performance				X	

Appendix A: Test results

Index

1. TEST CONDITIONS	9
1.1 Power supply (V)	9
1.2 Test frequencies and output power	9
1.3 EUT orientation and setup requirements	9
2. TEST RESULTS	11
2.1 Transmitter performance	11
2.2 Receiver performance	11
3. EXPANDED MEASUREMENT UNCERTAINTIES	12
4. RF TEST RESULT ON 2D	13
4.1 EIRP Pattern 863.1 MHz – Free Space	13
4.2 EIRP Pattern 865.1 MHz – Free Space	14
4.3 EIRP Pattern 868.3 MHz – Free Space	16
4.4 EIRP Pattern 869.525 MHz – Free Space	17
5. RF TEST RESULT ON 3D	19
5.1 TRP 863.1 MHz – Free Space	19
5.2 TRP 865.1 MHz – Free Space	22
5.3 TRP 868.3 MHz – Free Space	25
5.4 TRP 869.525 MHz – Free Space	28
6. RANGE REFERENCE MEASUREMENT DATA	31

1. TEST CONDITIONS

1.1 Power supply (V)

Power supply (V) under test:

$V_n = 3.6 V_{DC}$ supplied by a Lithium battery.

1.2 Test frequencies and output power

In all required operating bands the measurements for Total Radiated Power (TRP) and Total Isotropic Sensitivity (TIS) measurements are to be performed on channels and data-rates defined by the standard [1].

The “TX Power” parameter was set to 0 (maximum EIRP), 3 and 6 for TRP tests and 0 for TIS tests.

1.3 EUT orientation and setup requirements

The EUT is rotated along two different spherical axes: theta (θ) and phi (Φ). The relationship between the 3D Cartesian coordinate system (X, Y, Z) and the theta and phi axes is illustrated in the following figure. This coordinate system should be used as reference in all 3D radiation pattern graphs in section 4 as well as test setup photographs in Appendix B.

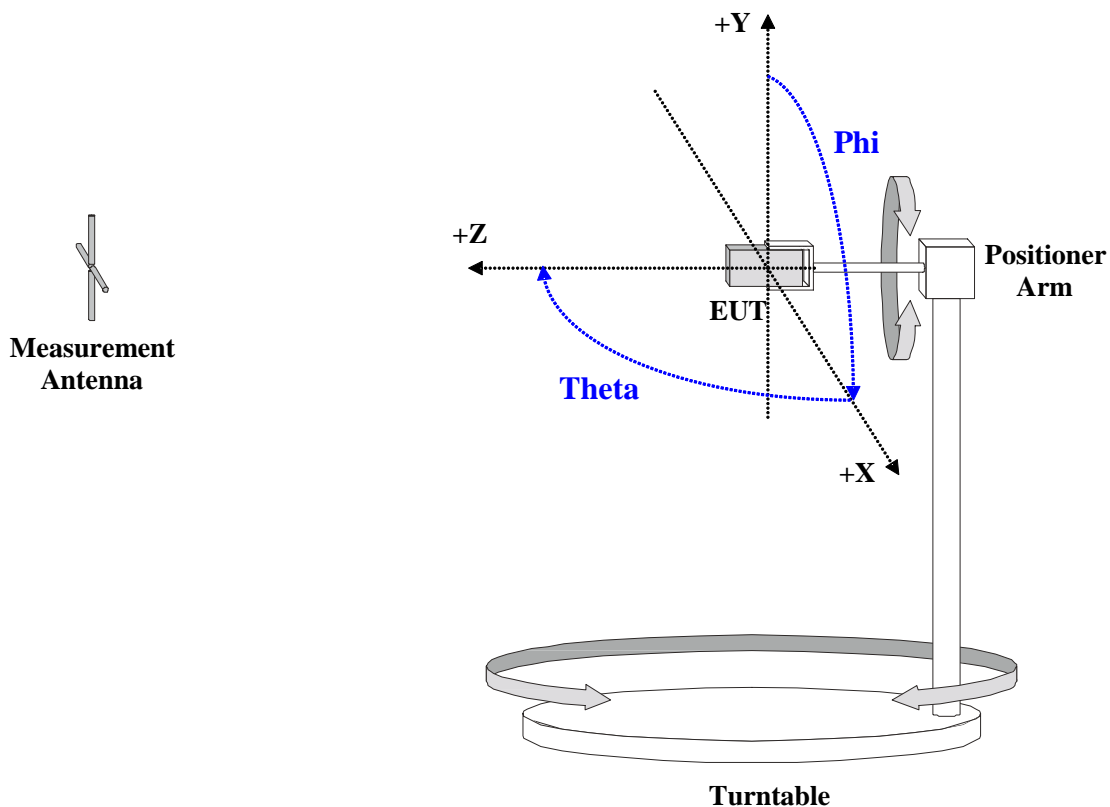

Fig. 1. Coordinate system.

Theta is the spherical axis that rotates along the Cartesian Y axis while Phi is the spherical axis that rotates along the Cartesian Z axis. The initial measurement position (Theta = 0° and Phi = 0°) is illustrated in each of the test setup photographs in Appendix B. The EUT has only one mechanical configuration each and they were tested in the “Free-space” configuration, whereby EUT has been placed directly on a support placed 2 meters away from the measurement antenna.

End-device transmitter performance

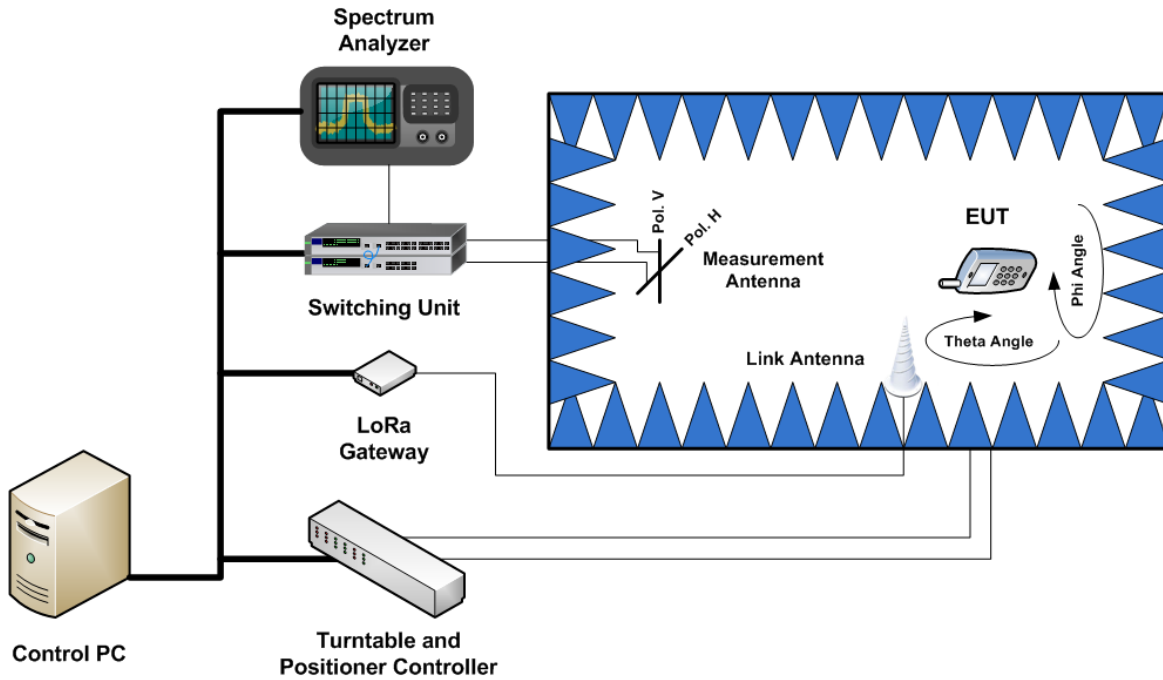

Fig. 2. Transmitter performance test connection diagram.

End-device receiver performance

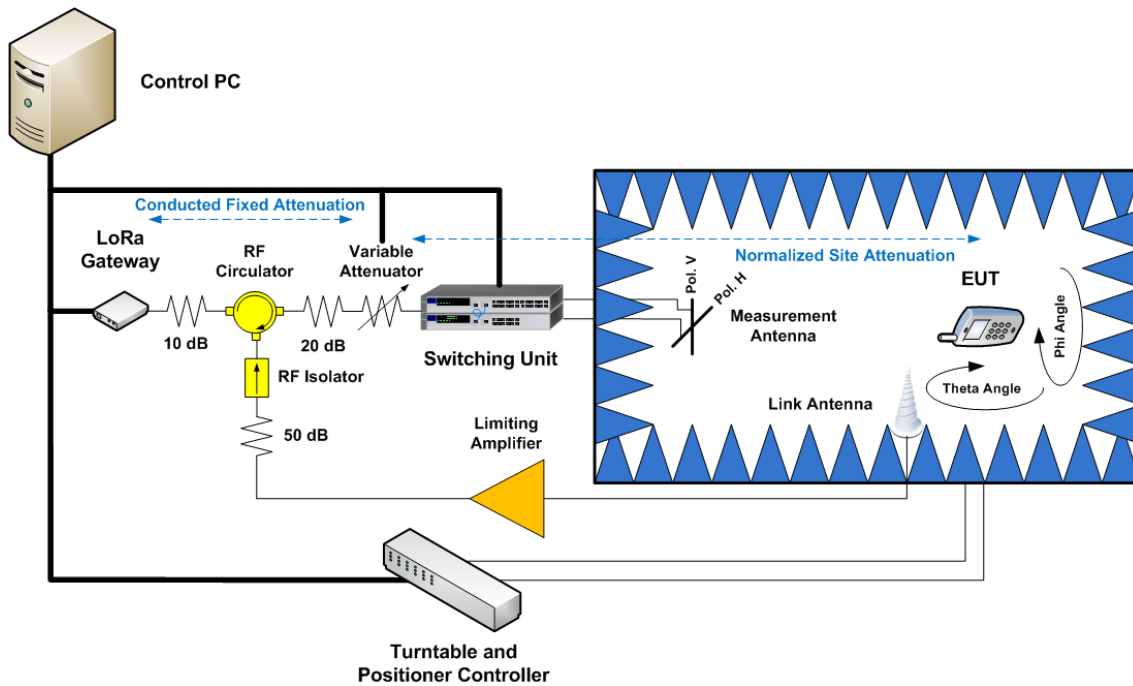

Fig. 3. Receiver performance test connection diagram.

2. TEST RESULTS

2.1 Transmitter performance

Frequency (MHz)	TX Power parameter	TRP (dBm)	Maximum EIRP				
			Horizontal EIRP (dBm)	Vertical EIRP (dBm)	Total EIRP (dBm)	Theta (°)	Phi (°)
863.1	0	10.38	10.31	8.72	12.60	105	75
	3	N/A	6.14	4.59	8.44	105	75
	6	N/A	-0.10	-1.69	2.19	105	75
865.1	0	10.06	10.06	8.06	12.18	75	30
	3	N/A	5.98	3.26	7.84	75	30
	6	N/A	-0.22	-3.13	1.57	75	30
868.3	0	9.99	10.06	7.98	12.15	90	75
	3	N/A	5.93	3.56	7.92	90	75
	6	N/A	-0.46	-2.63	1.60	90	75
869.525	0	9.95	10.26	7.45	12.09	75	45

2.2 Receiver performance

Frequency (MHz)		863.1	865.1	869.525	
Spreading Factor		SF12 (DR0)	SF12 (DR0)	SF12 (DR0)	SF7 (DR5)
TIS (dBm)		-134.38	-135.86	-134.22	-122.55
Measured EIS	EIS (dBm)	-136.07	-136.72	-134.82	-123.15
	PER (%)	8.30	8.30	6.60	5.00
	Polarization	Horizontal	Horizontal	Horizontal	Horizontal
	Theta (°)	120	135	90	90
	Phi (°)	135	150	90	90
GW Tx Power (dBm)		9.16	11.61	13.20	13.20
Forward path attenuation (dB)		-145.23	-148.33	-148.02	-136.35
Normalized Site Attenuation (NSA) (dB) ¹		-51.61	-51.69	-51.87	-51.87
Conducted fixed attenuation (dB) ¹		-93.61	-96.63	-96.15	-84.48
RF Path attenuation step size (dB)		0.50	0.50	0.50	0.50

¹ For details on what elements are accounted for in Normalized Site Attenuation and Conducted Fixed Attenuation components see Figure 3.

3. EXPANDED MEASUREMENT UNCERTAINTIES

The expanded measurement uncertainties are listed below for the different frequency bands. These uncertainties refer to a coverage factor of 2, corresponding to 95% confidence level.

The expanded measurement uncertainties listed below were derived following the methodology described in the CTIA Test plan for mobile station over the air performance. Method of measurement for radiated RF power and receiver performance. April 2019. Revision 3.8.2.

Table 1. **TRP and TIS Measurement Uncertainty results**

Test	Test Configuration	Expanded Uncertainty (k=2, 95 % confidence level) [dB]	
		Value (dB)	LoRaWAN End-Device RF Performance measurements for All Regions Uncertainty Limit (dB)
TRP	FREE SPACE	1.60	3.0
TIS	FREE SPACE	1.77	3.5

4. RF TEST RESULT ON 2D

4.1 EIRP Pattern 863.1 MHz – Free Space

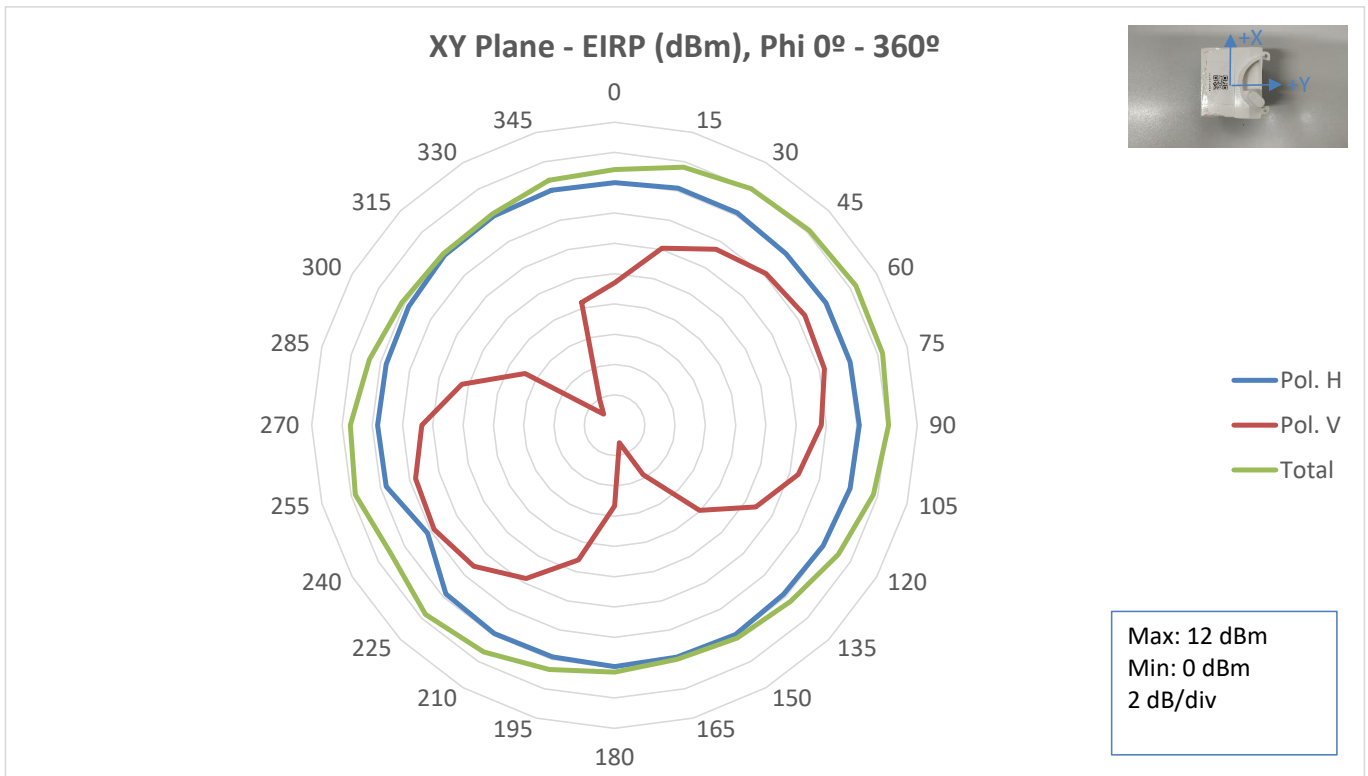

Fig. 4. XY Plane EIRP, Free Space, 863.1 MHz.

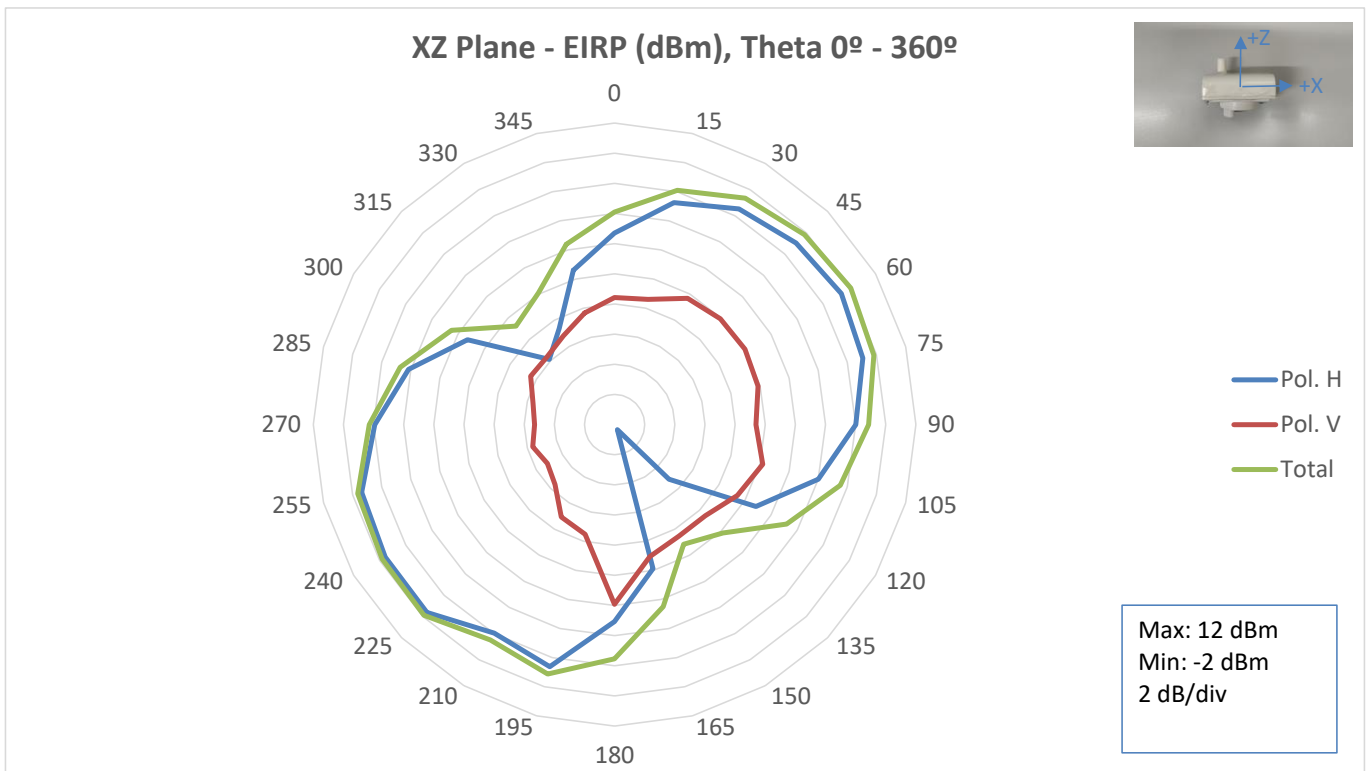

Fig. 5. XZ Plane EIRP, Free Space, 863.1 MHz.

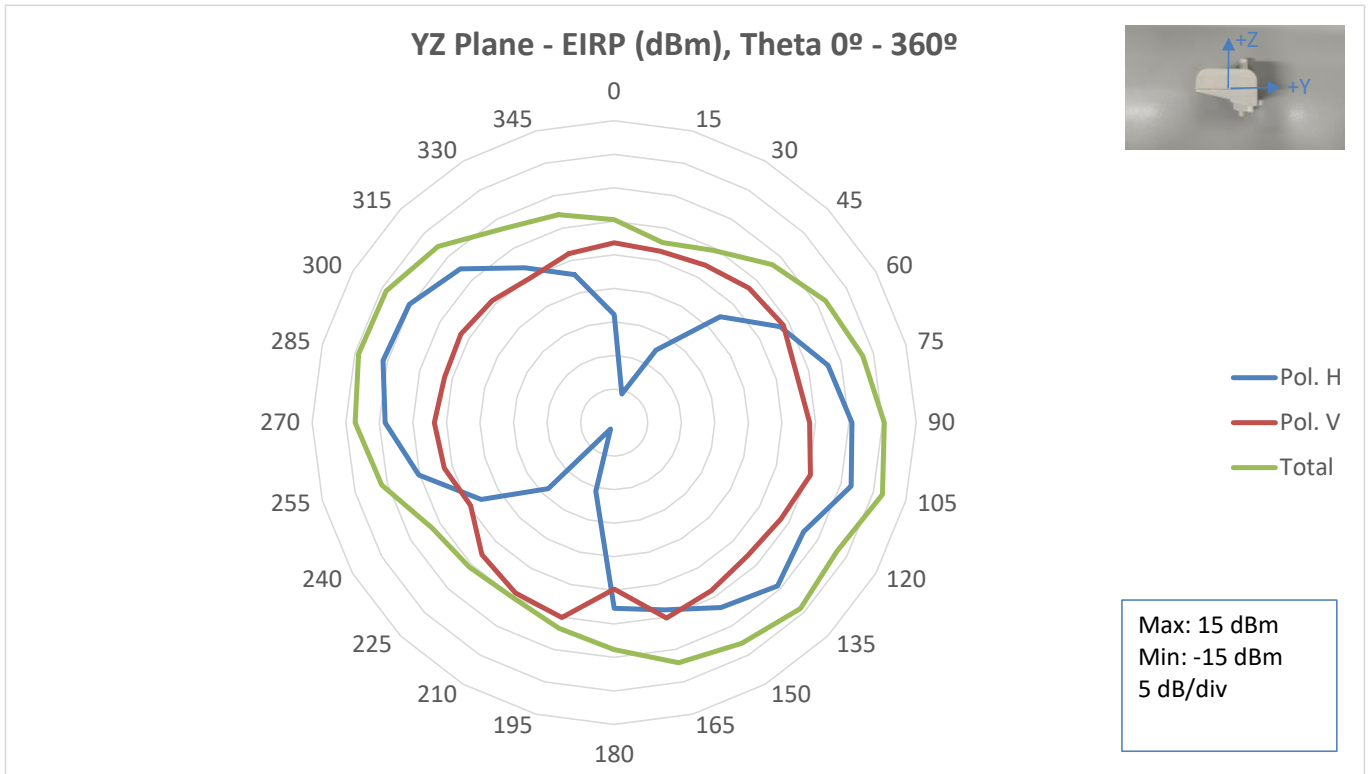

Fig. 6. YZ Plane EIRP, Free Space, 863.1 MHz.

4.2 EIRP Pattern 865.1 MHz – Free Space

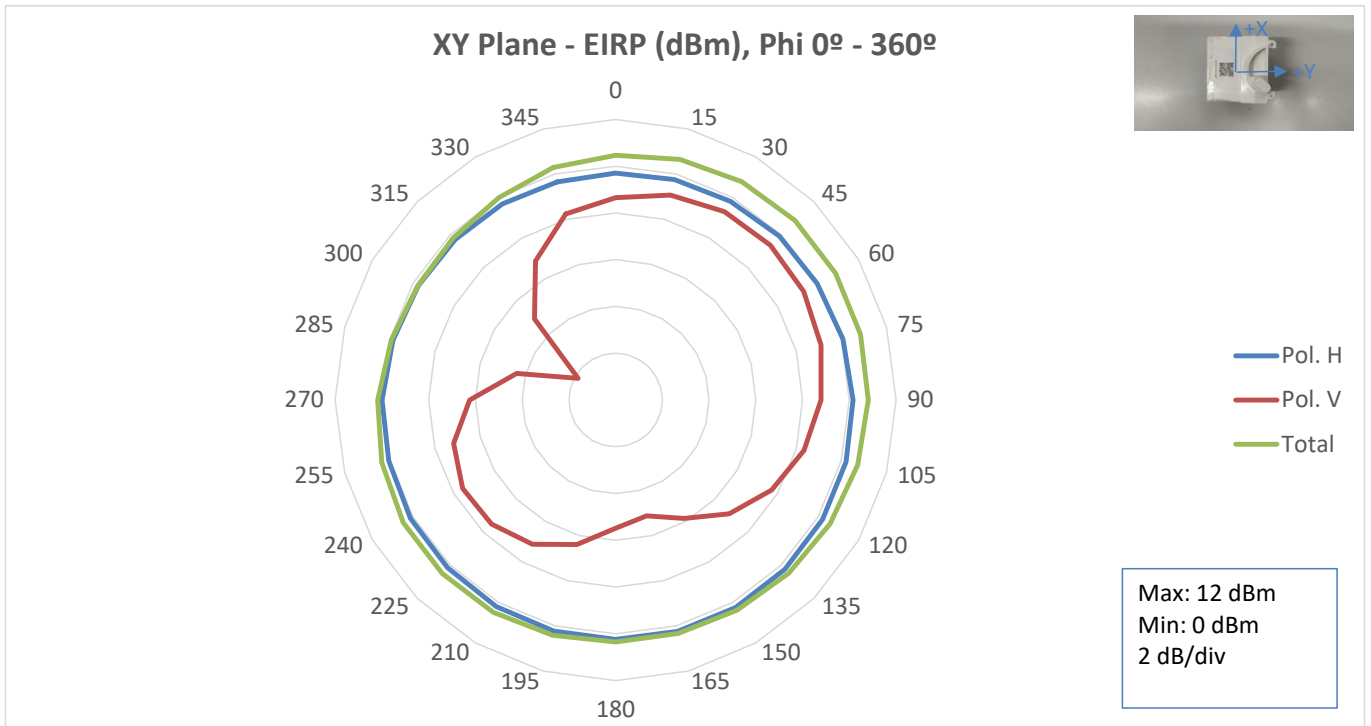

Fig. 7. XY Plane EIRP, Free Space, 865.1 MHz.

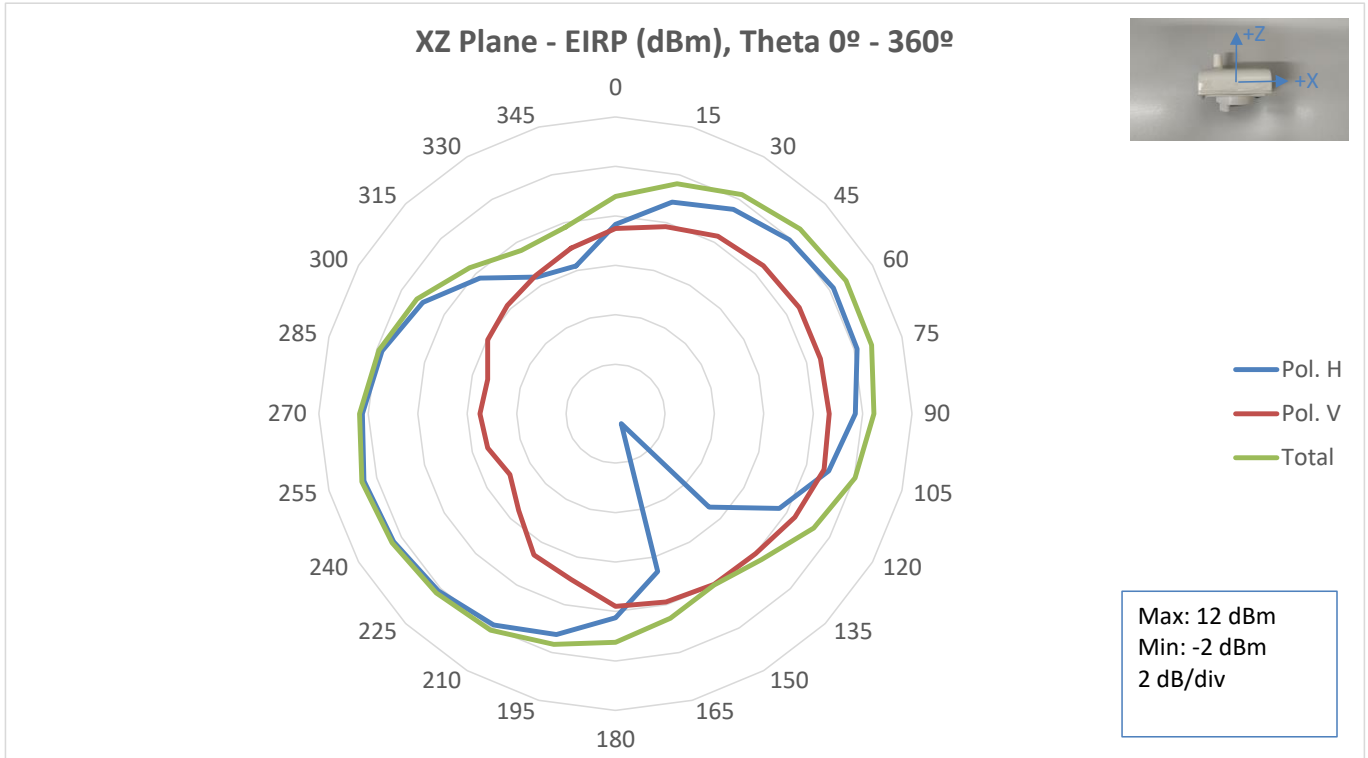

Fig. 8. XZ Plane EIRP, Free Space, 865.1 MHz.

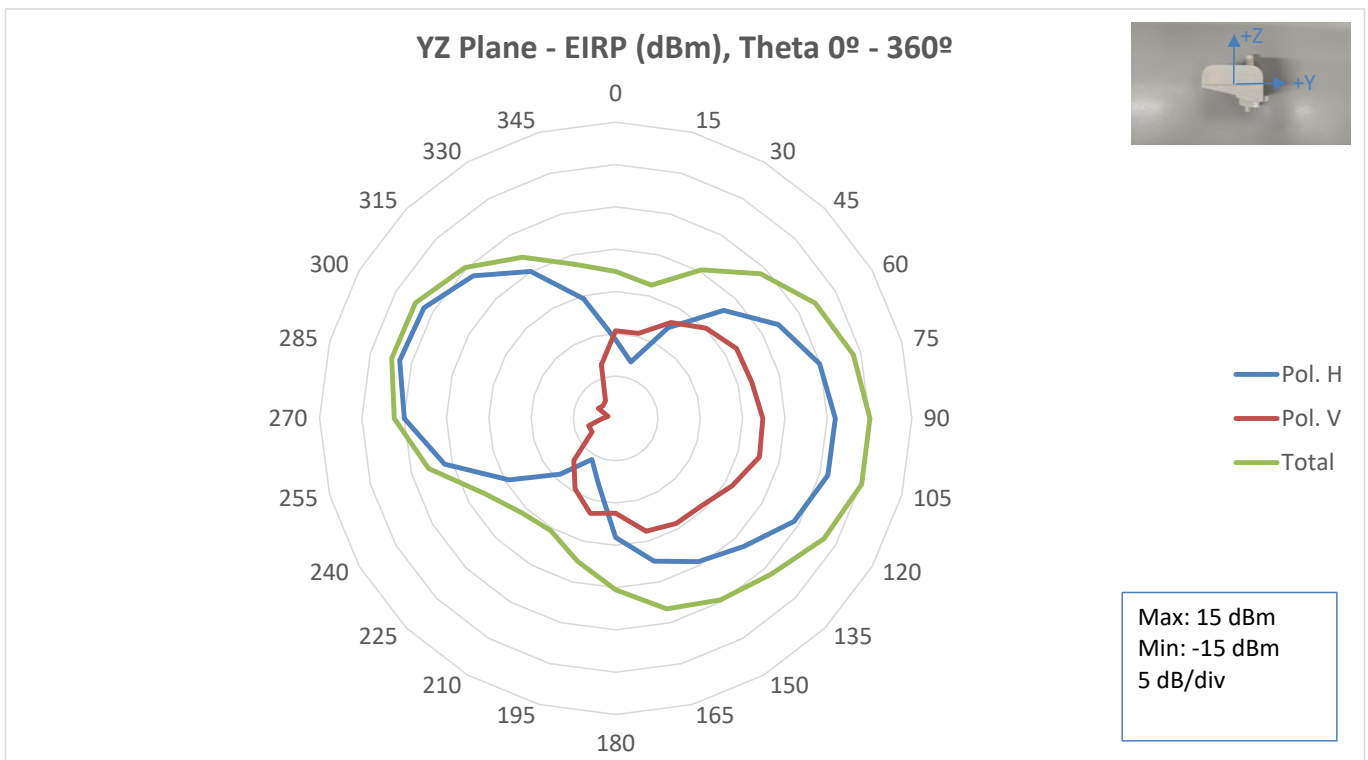

Fig. 9. YZ Plane EIRP, Free Space, 865.1 MHz.

4.3 EIRP Pattern 868.3 MHz – Free Space

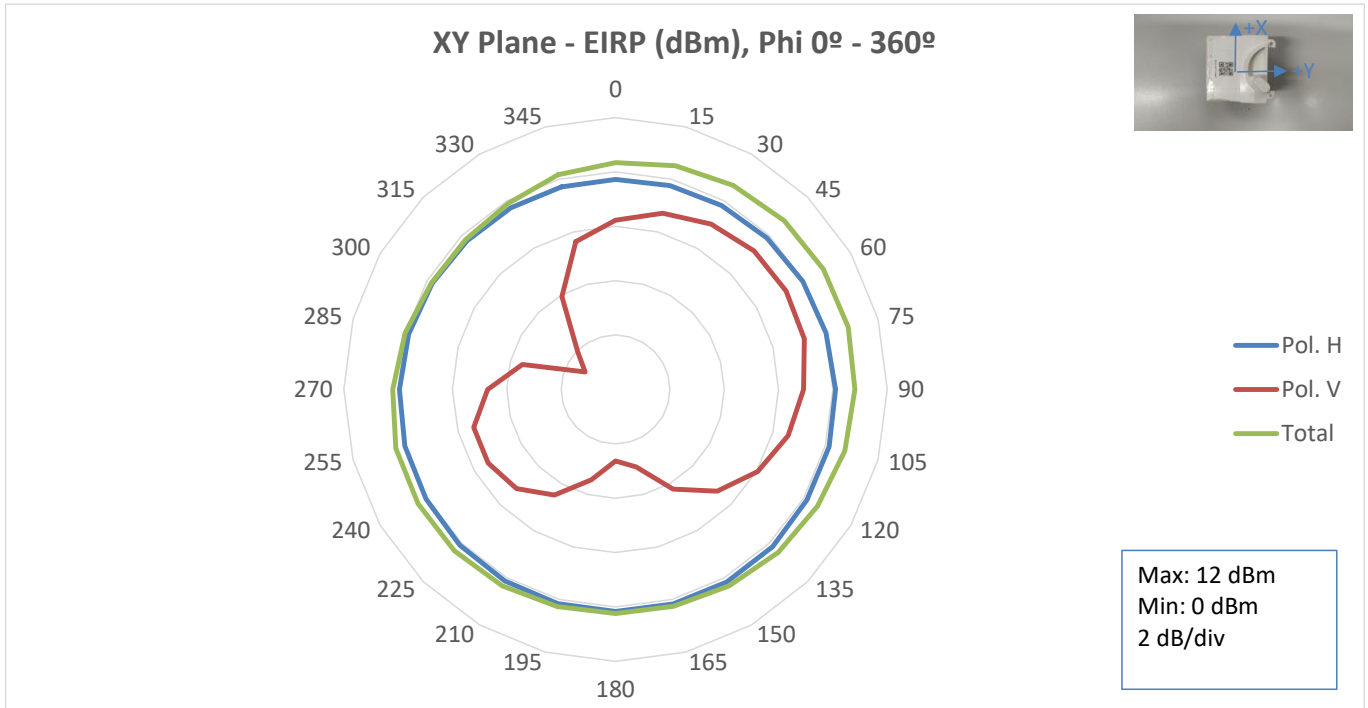

Fig. 10. XY Plane EIRP, Free Space, 868.3 MHz.

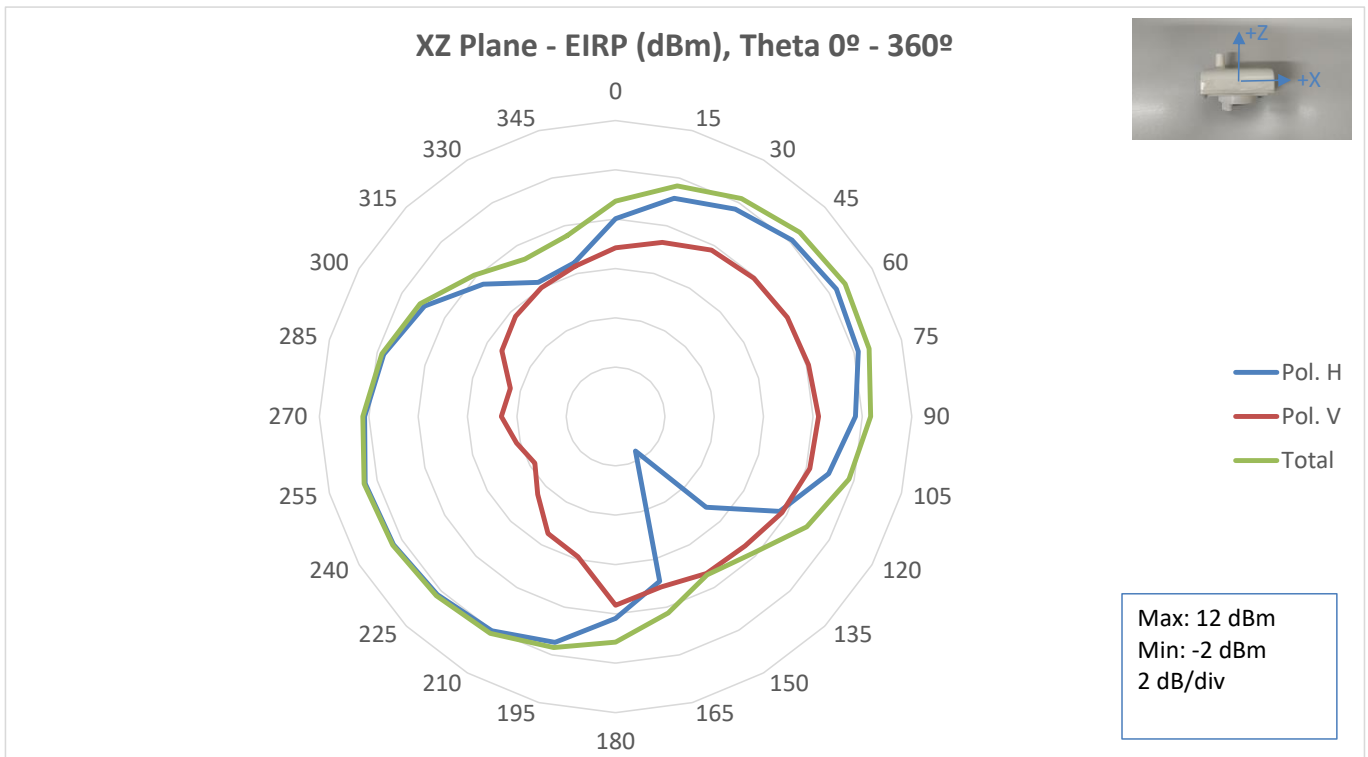

Fig. 11. XZ Plane EIRP, Free Space, 868.3 MHz.

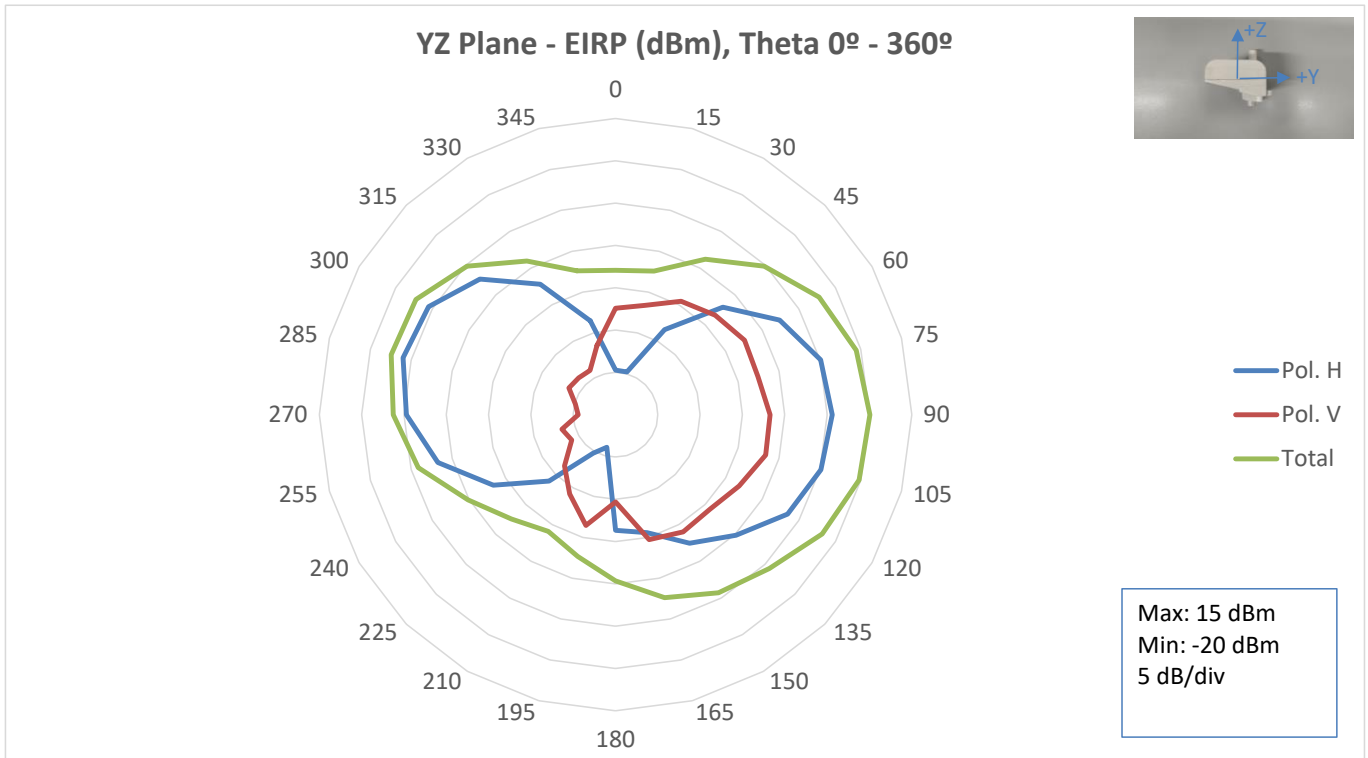

Fig. 12. YZ Plane EIRP, Free Space, 868.3 MHz.

4.4 EIRP Pattern 869.525 MHz – Free Space

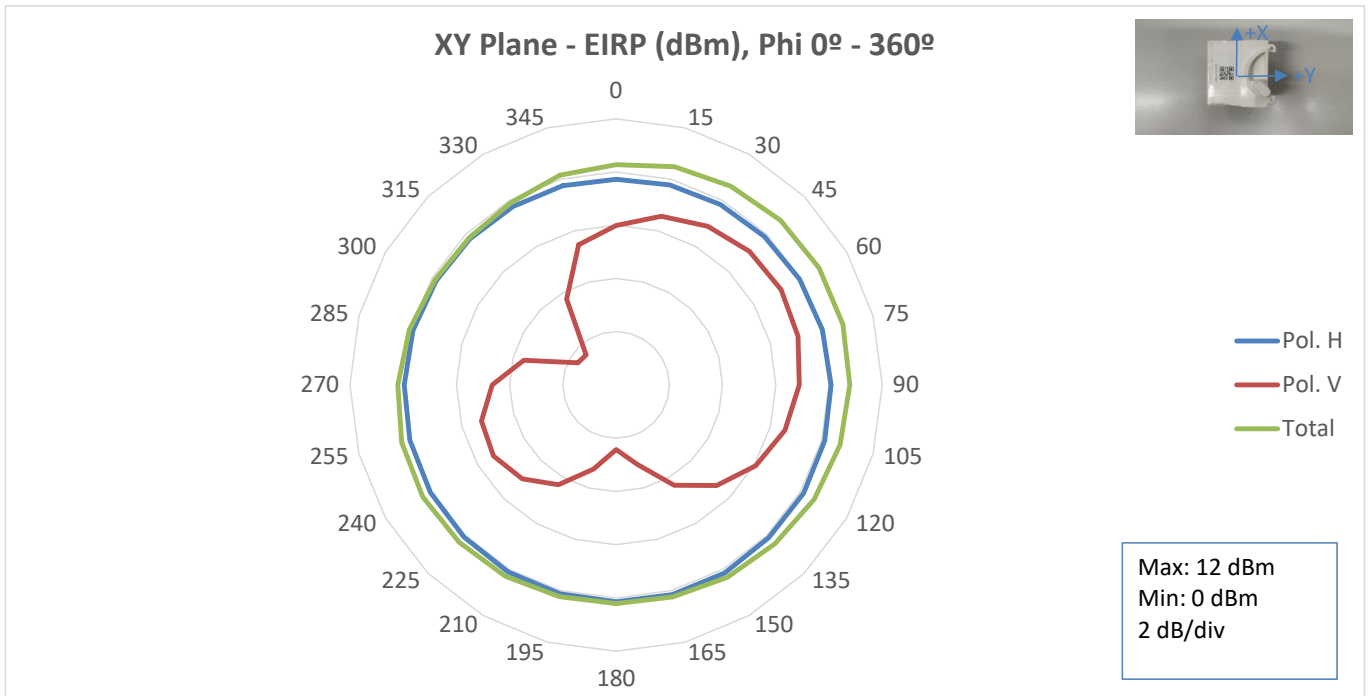

Fig. 13. XY Plane EIRP, Free Space, 869.525 MHz.

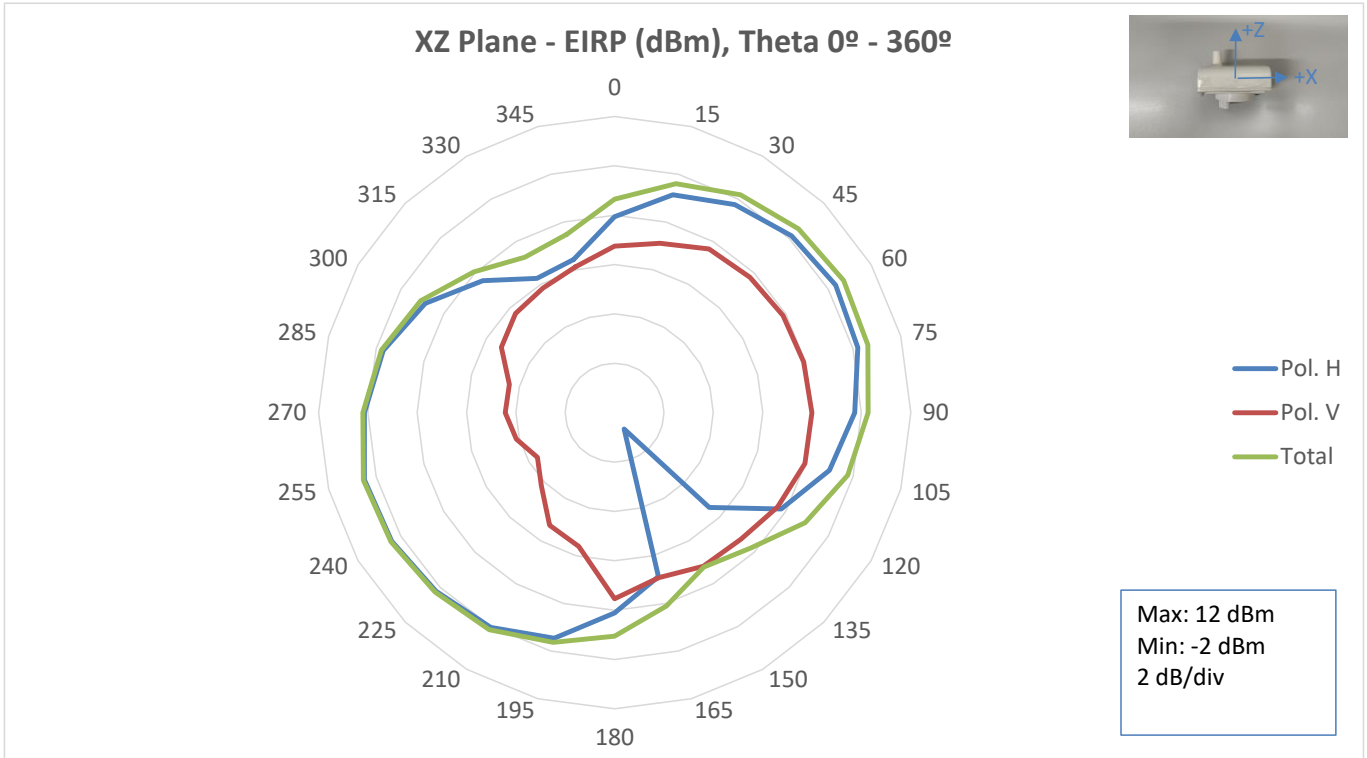

Fig. 14. XZ Plane EIRP, Free Space, 869.525 MHz.

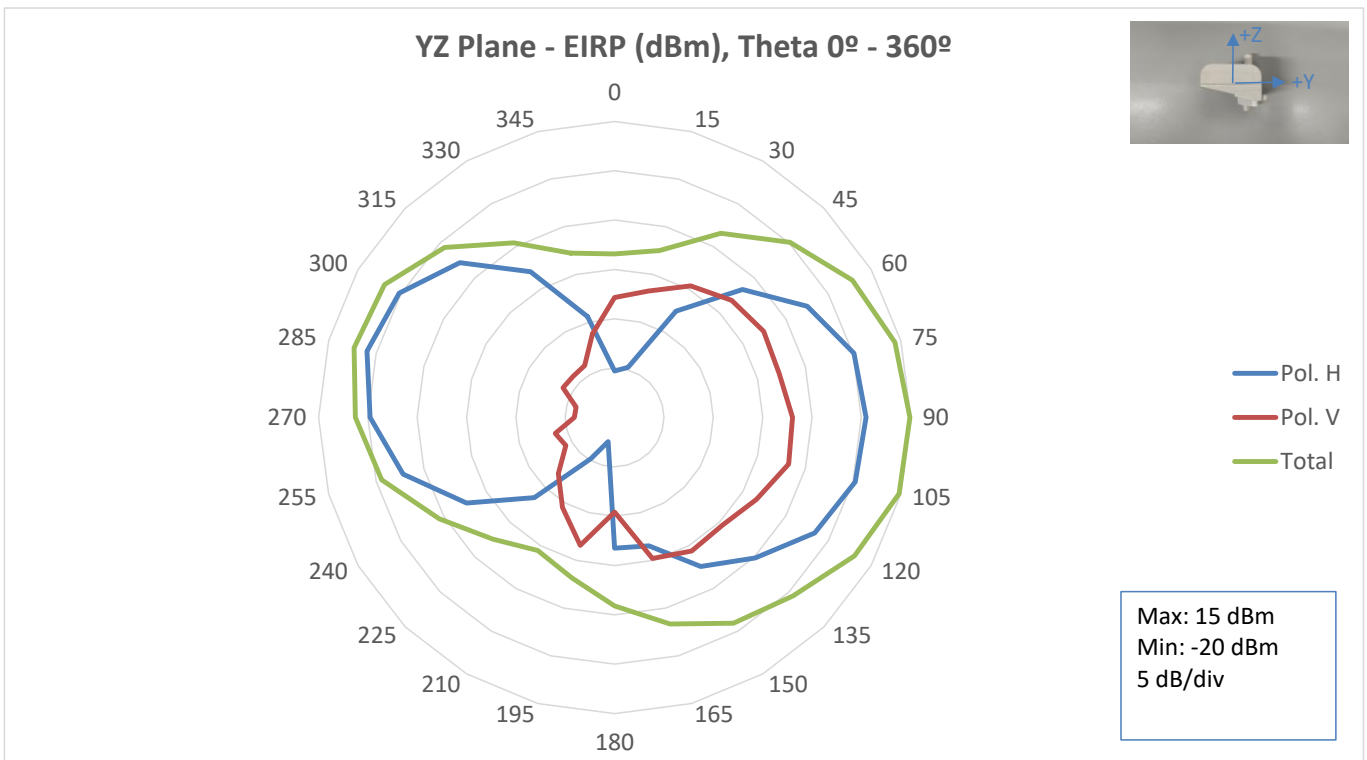

Fig. 15. YZ Plane EIRP, Free Space, 869.525 MHz.

5. RF TEST RESULT ON 3D

5.1 TRP 863.1 MHz – Free Space

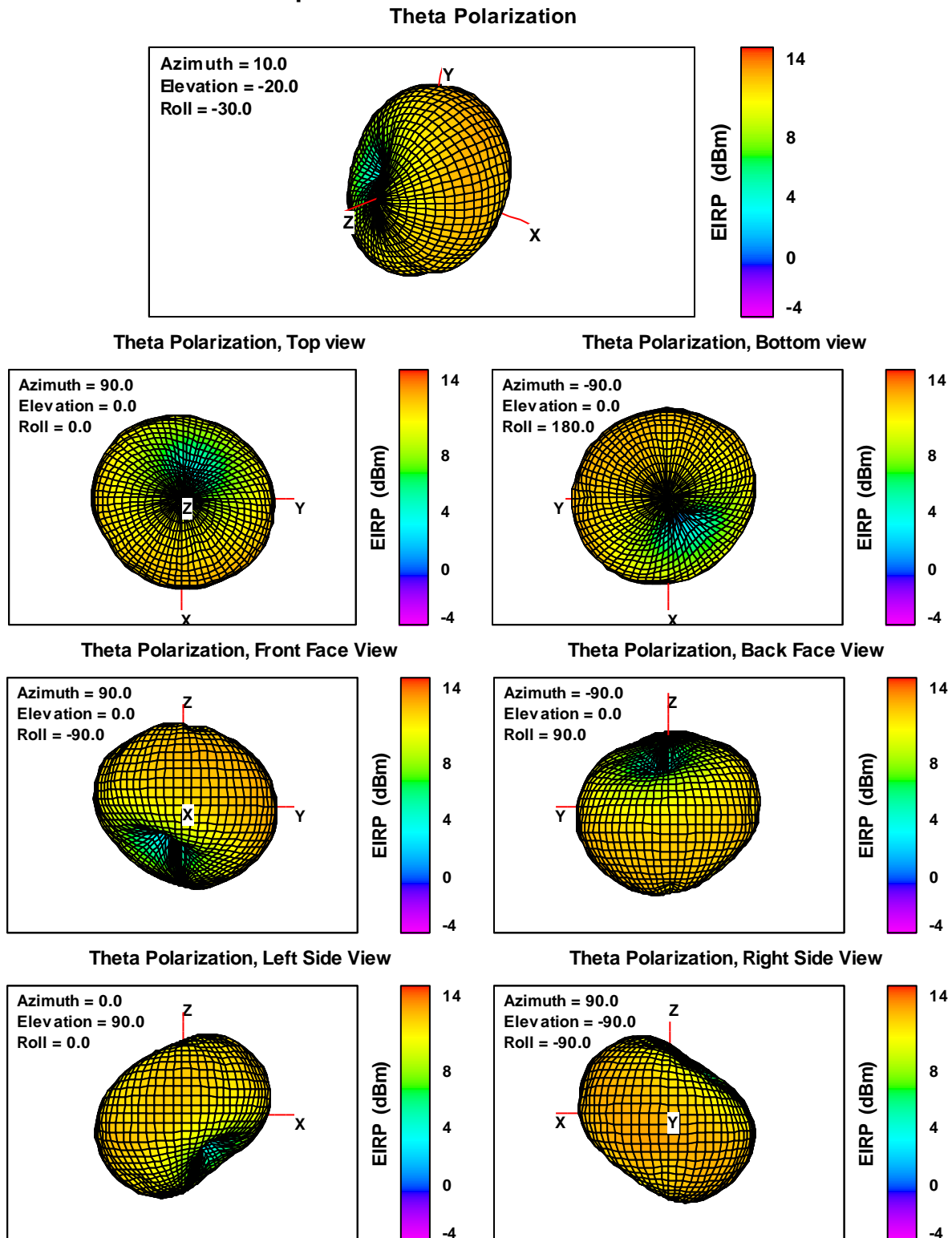

Fig. 16. Theta Polarization (Horizontal) EIRP, Free Space, 863.1 MHz.

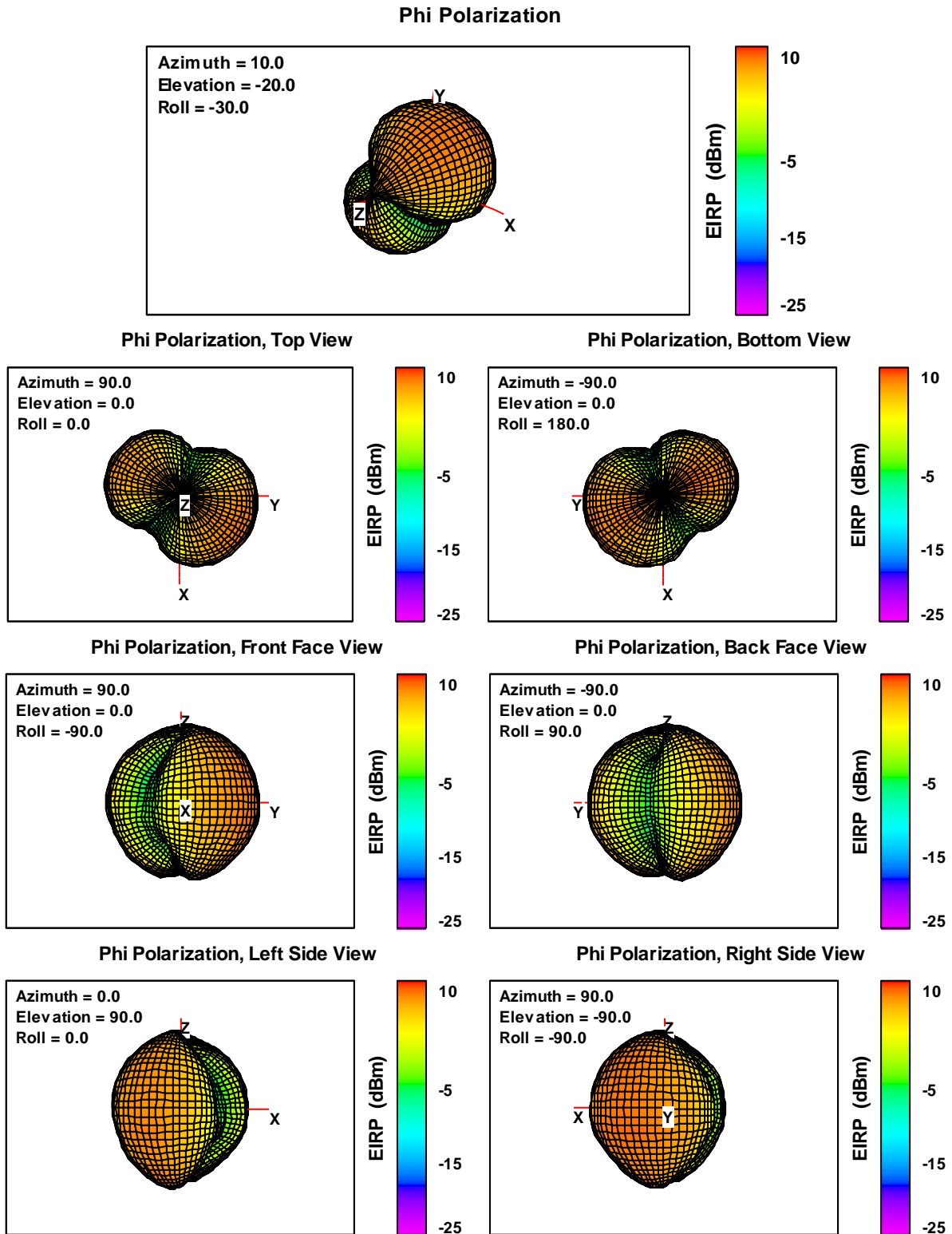

Fig. 17. Phi Polarization (Vertical) EIRP, Free Space, 863.1 MHz.

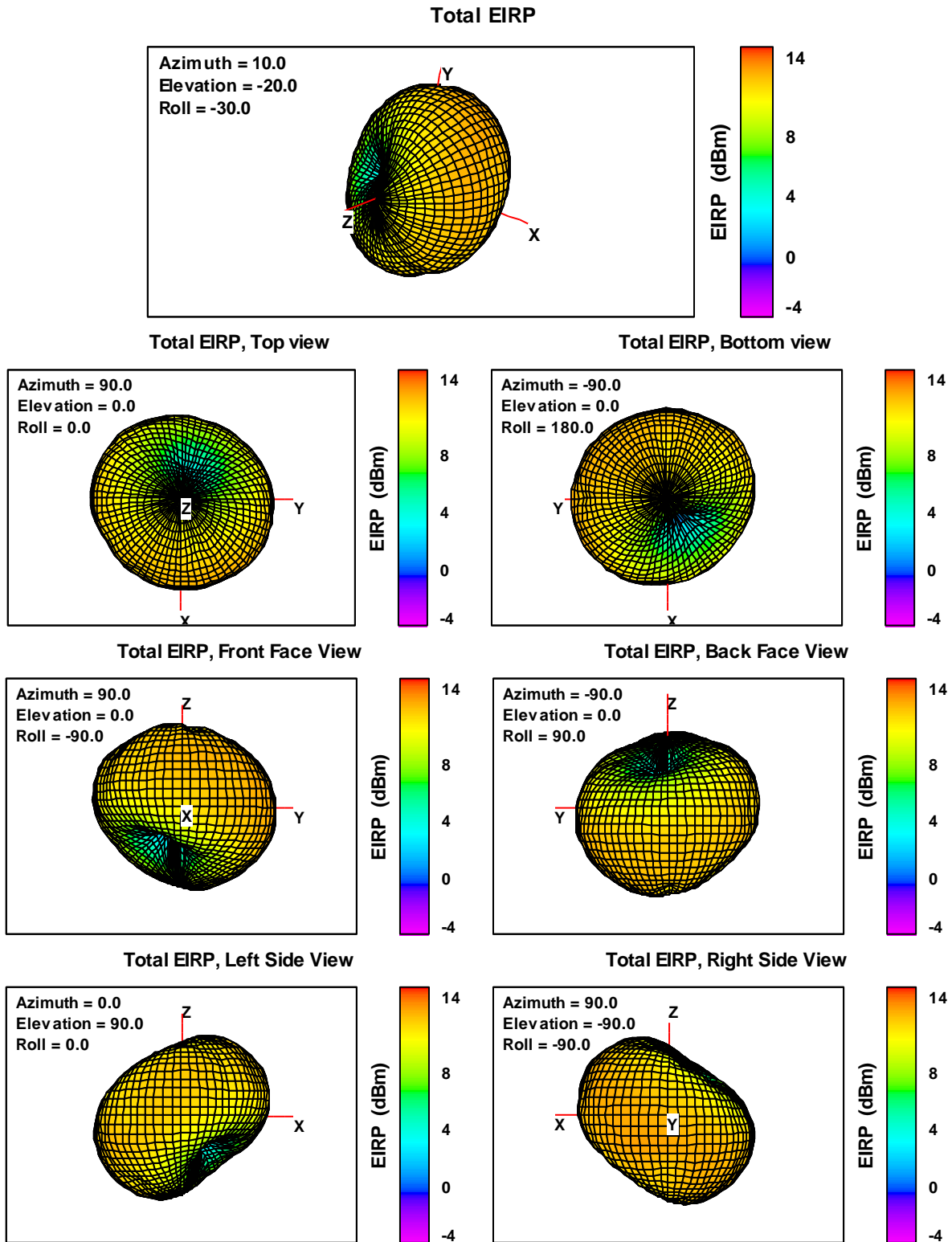

Fig. 18. Total EIRP, Free Space, 863.1 MHz.

5.2 TRP 865.1 MHz – Free Space

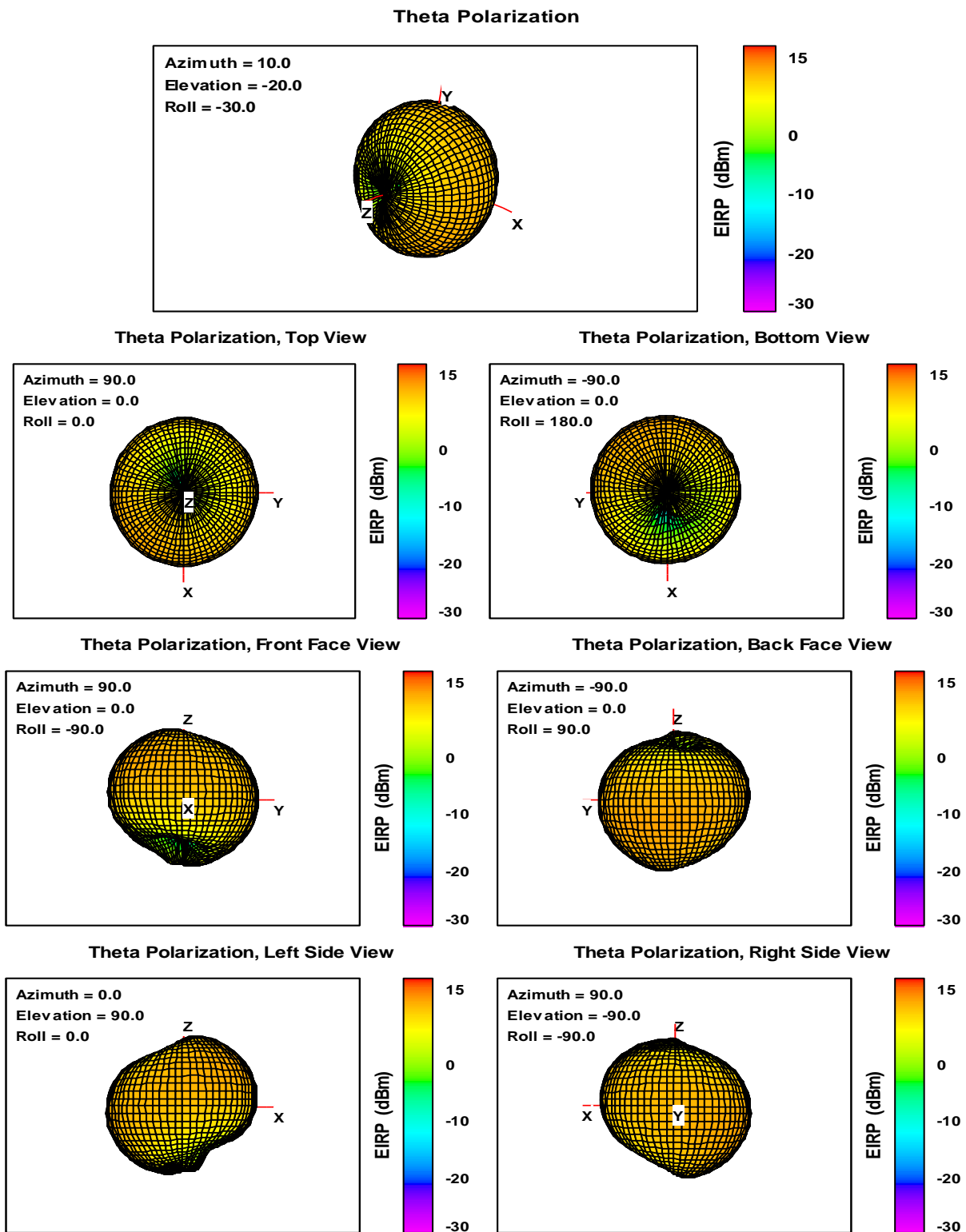

Fig. 19. Theta Polarization (Horizontal) EIRP, Free Space, 865.1 MHz.

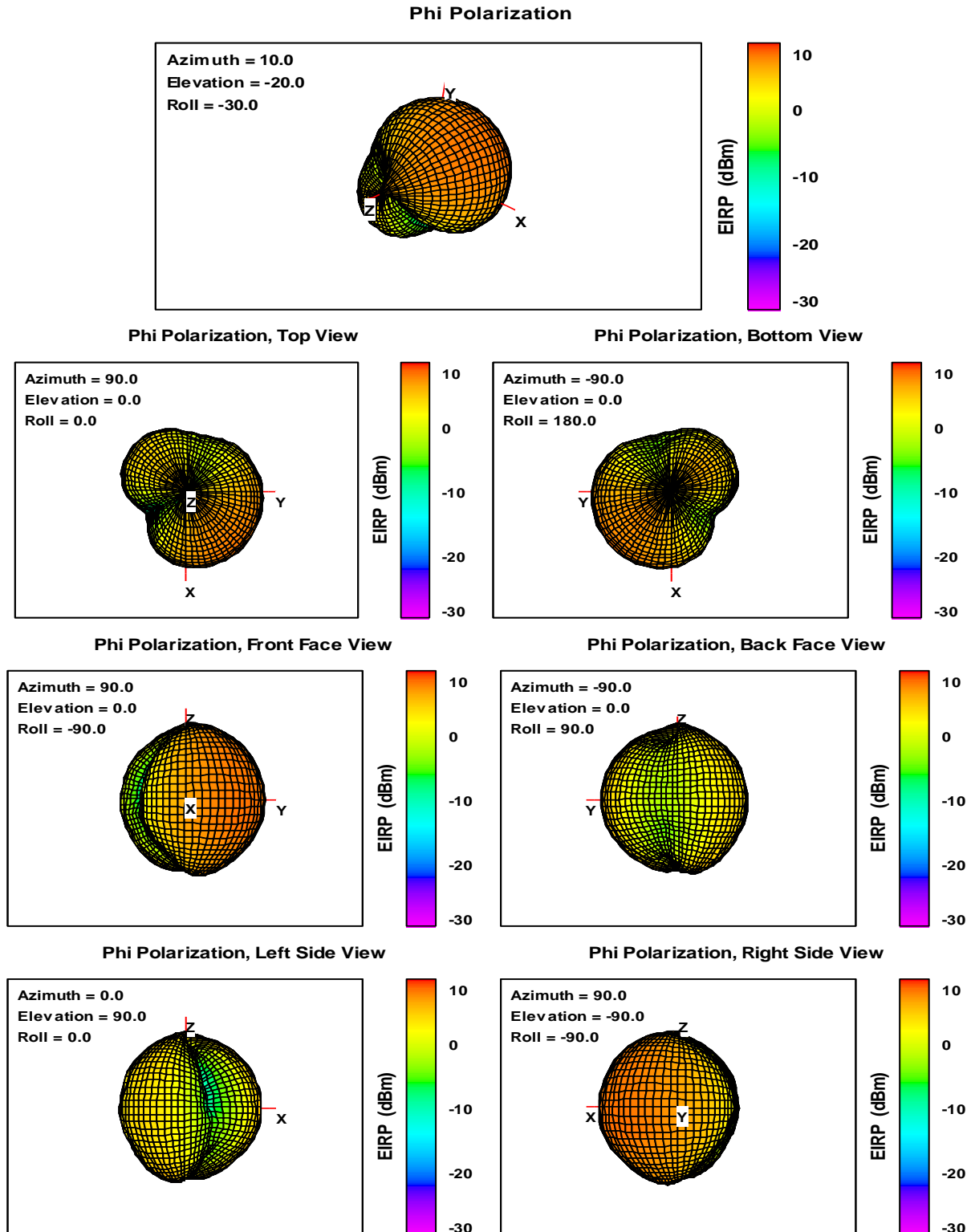

Fig. 20. Phi Polarization (Vertical) EIRP, Free Space, 865.1 MHz.

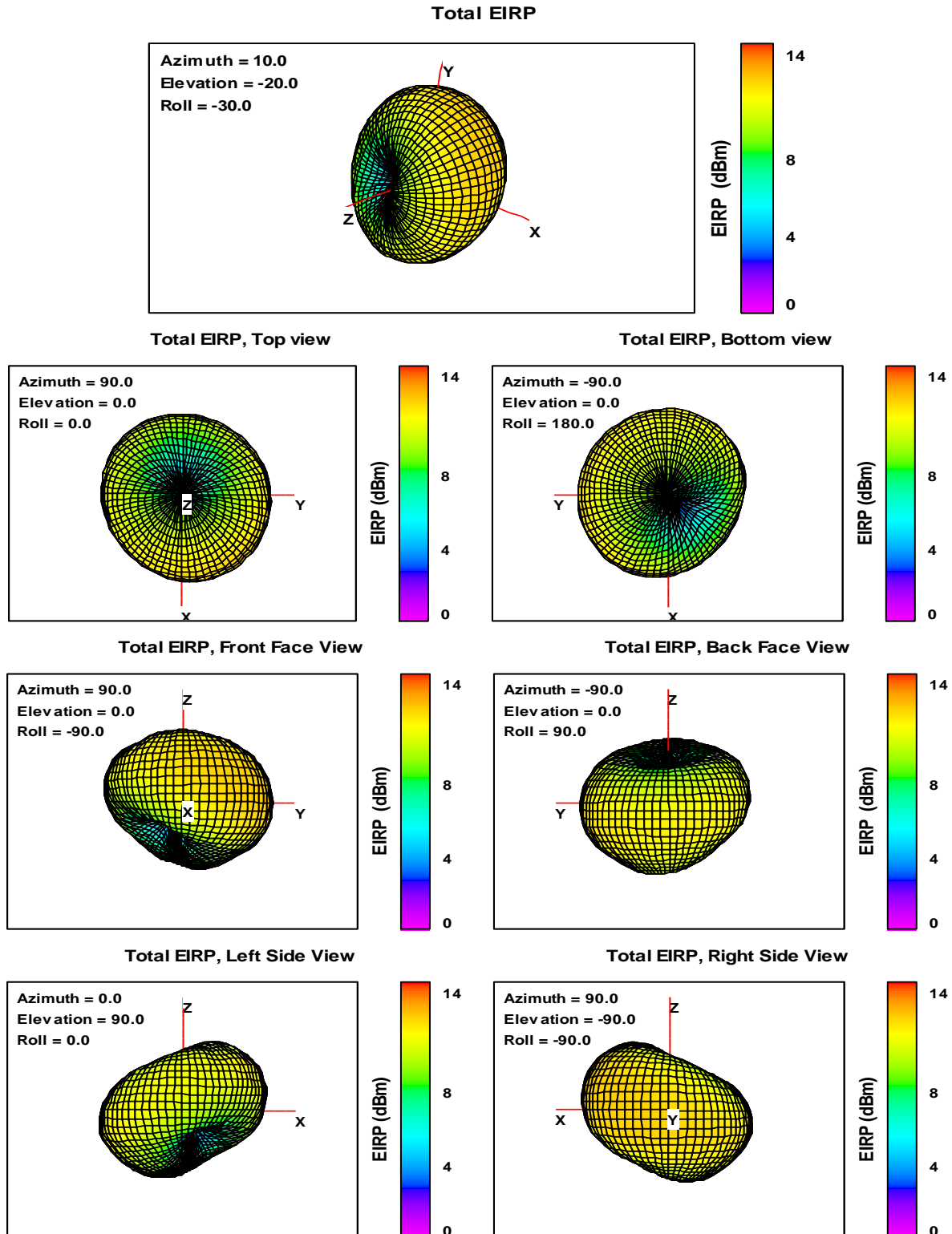

Fig. 21. Total EIRP, Free Space, 865.1 MHz.

5.3 TRP 868.3 MHz – Free Space

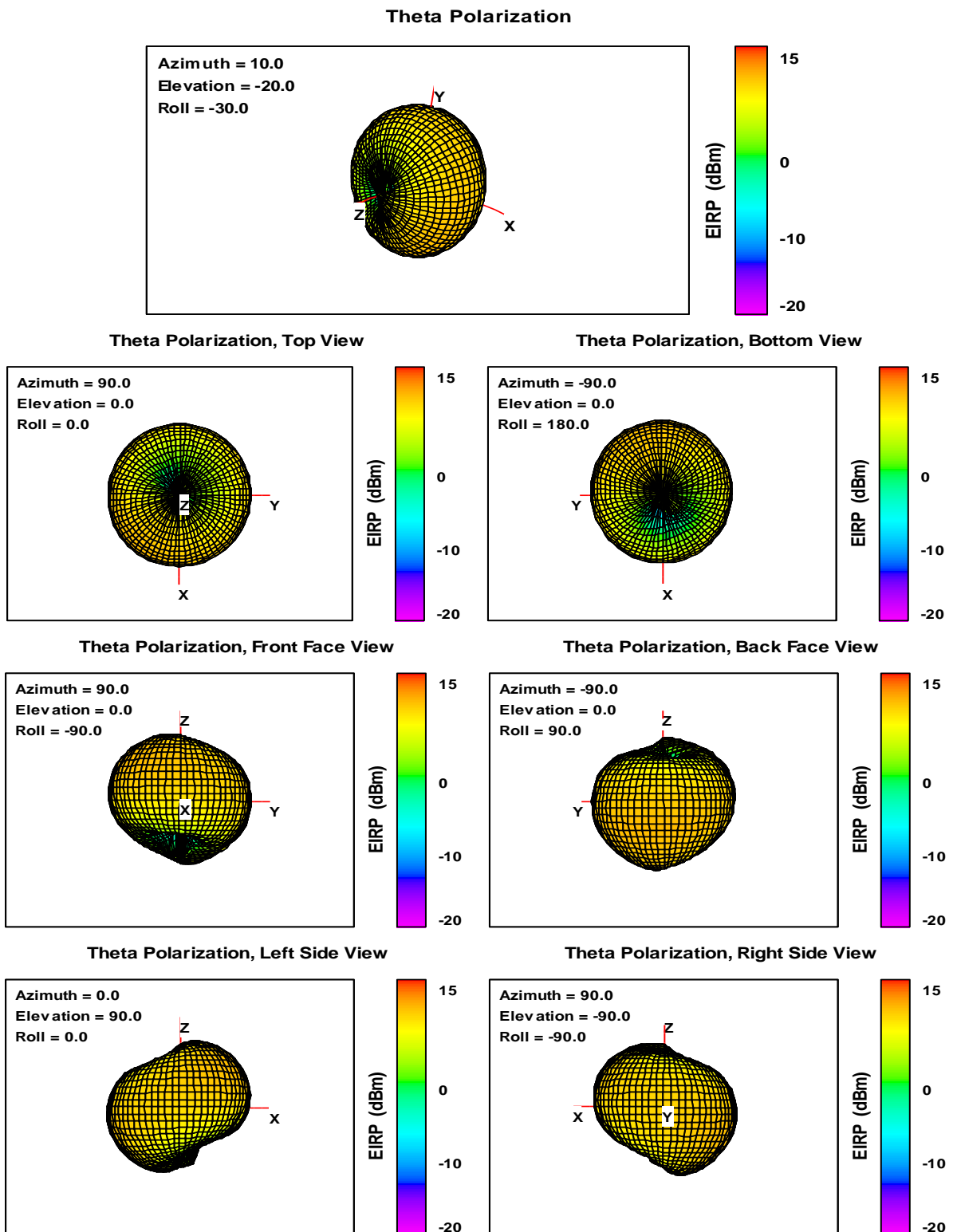

Fig. 22. Theta Polarization (Horizontal) EIRP, Free Space, 868.3 MHz.

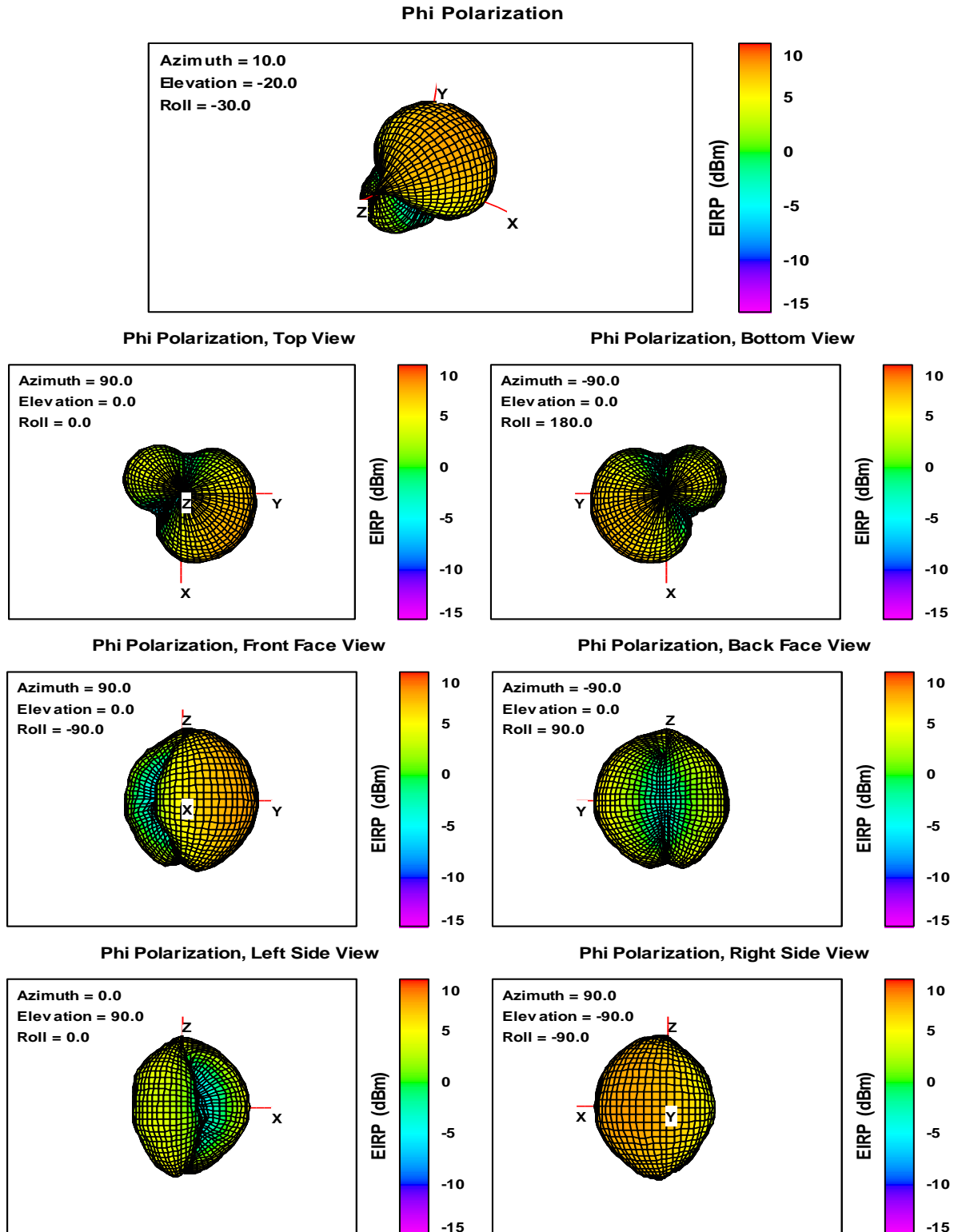

Fig. 23. Phi Polarization (Vertical) EIRP, Free Space, 868.3 MHz.

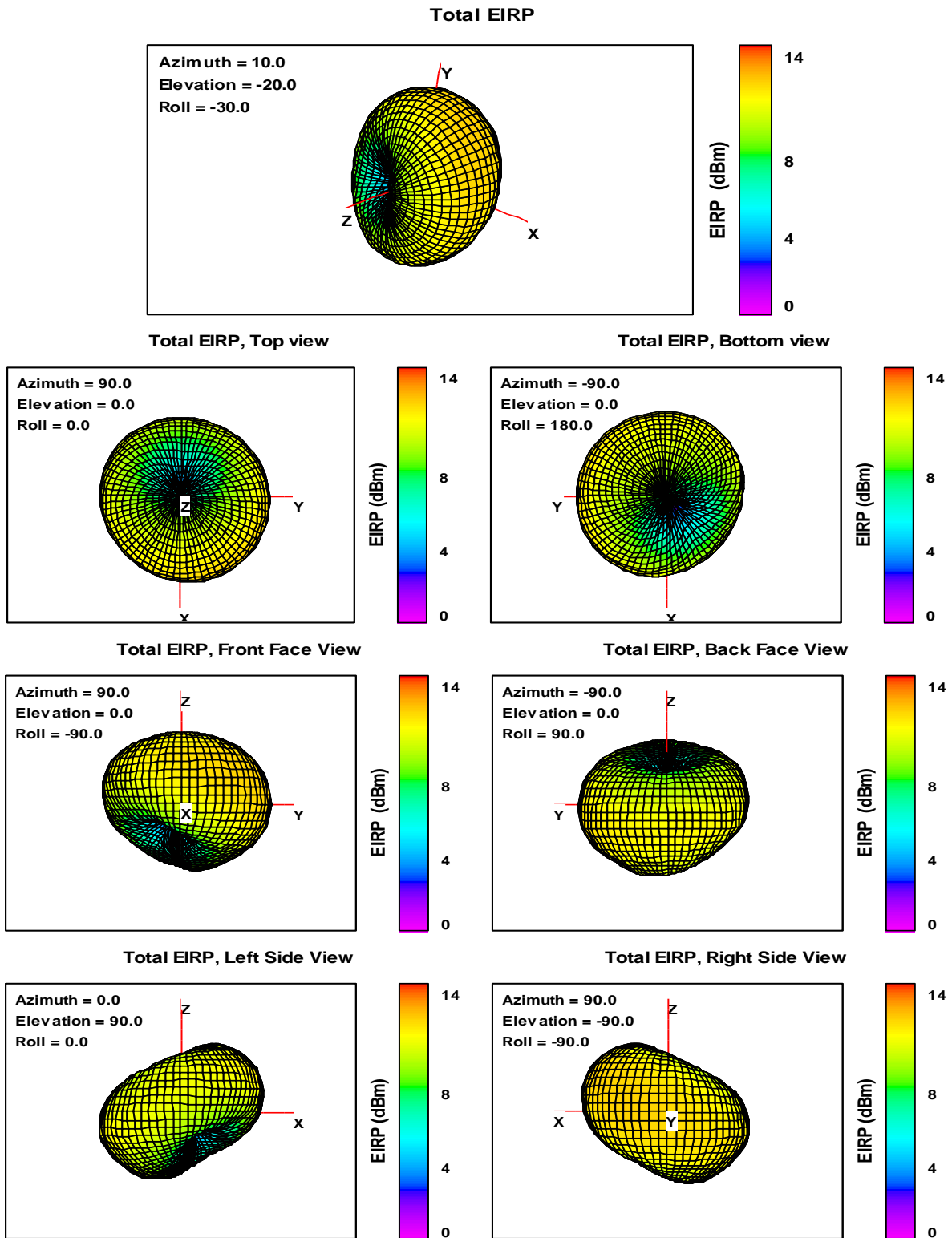

Fig. 24. Total EIRP, Free Space, 868.3 MHz.

5.4 TRP 869.525 MHz – Free Space

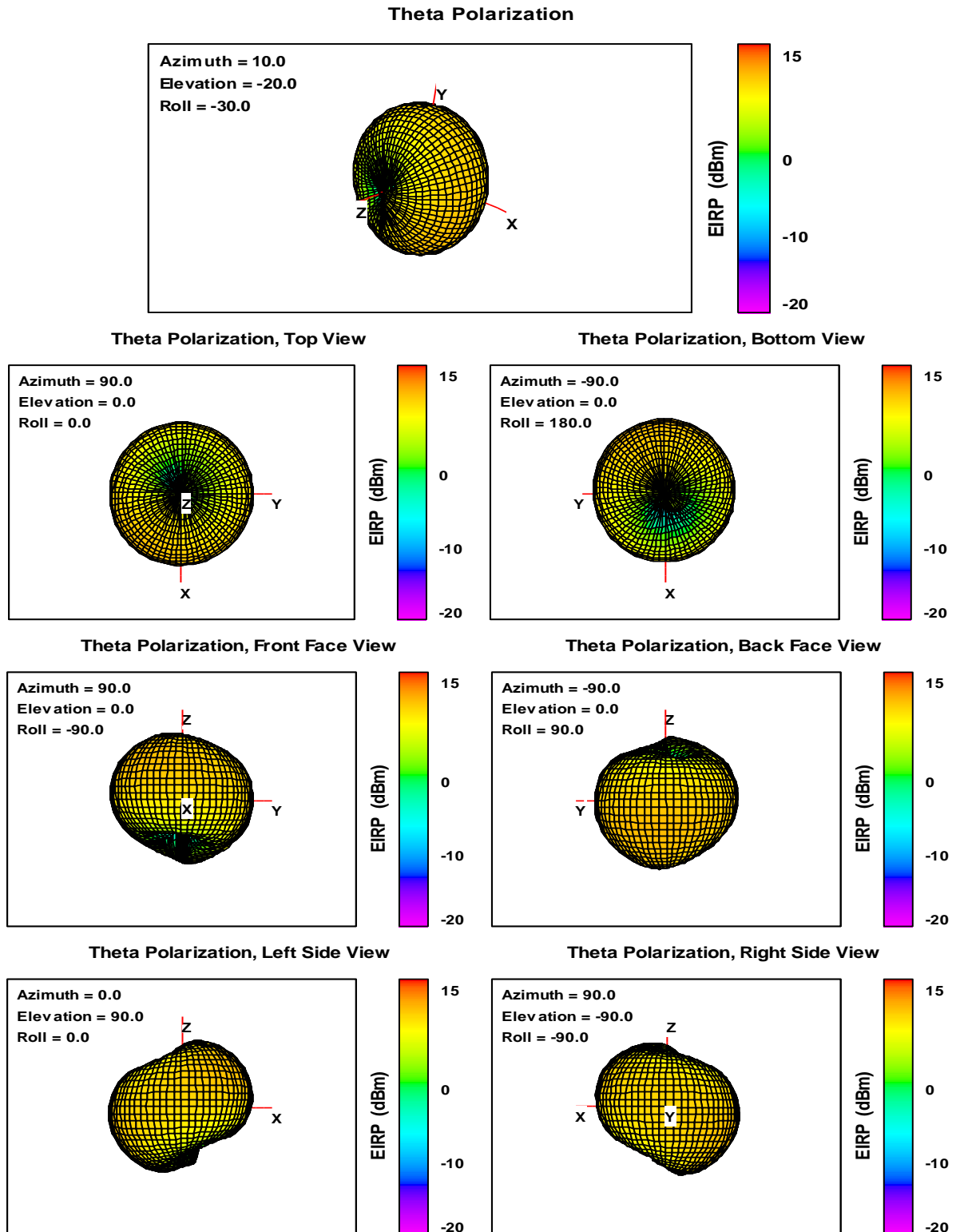

Fig. 25. Theta Polarization (Horizontal) EIRP, Free Space, 869.525 MHz.

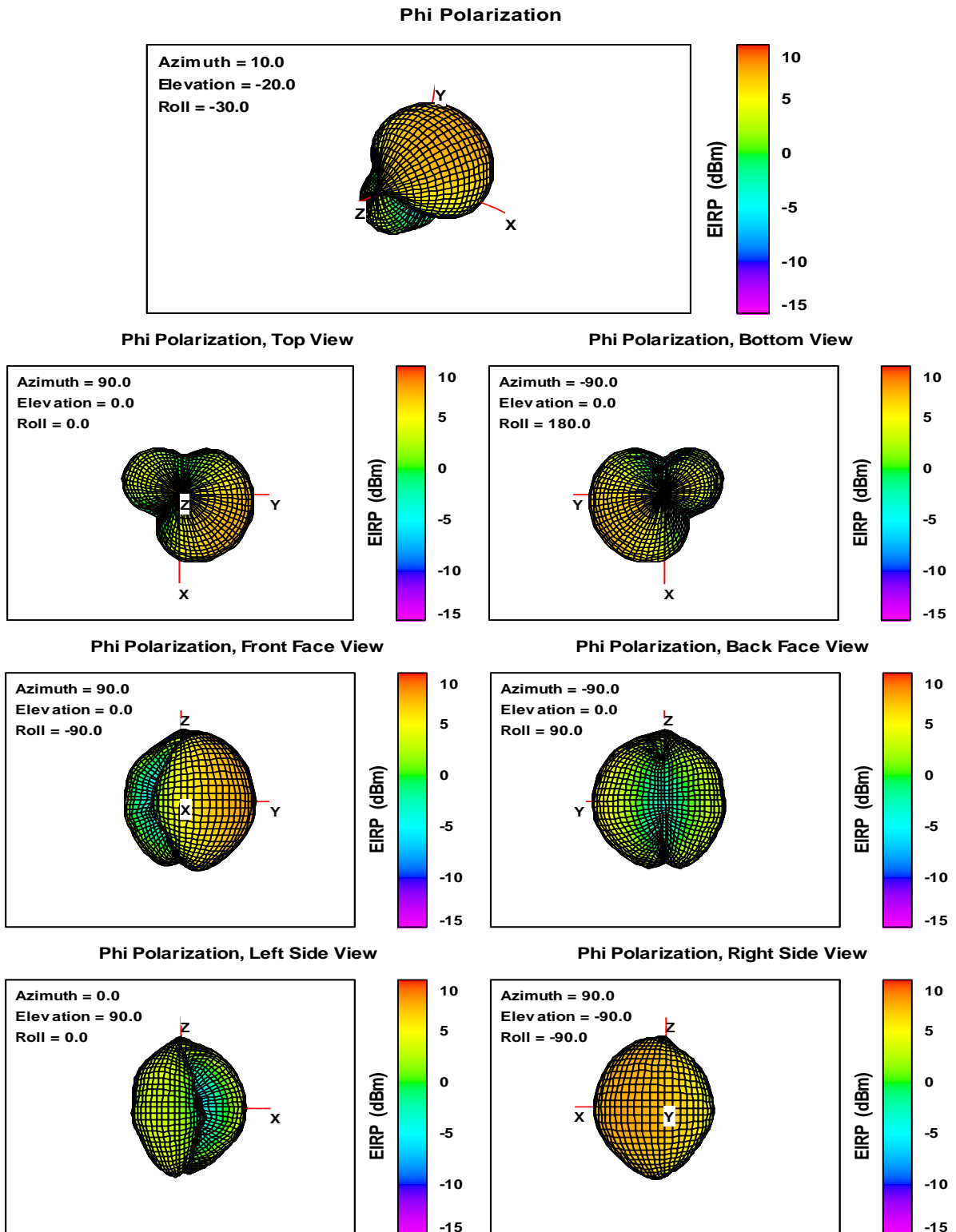

Fig. 26. Phi Polarization (Vertical) EIRP, Free Space, 869.525 MHz.

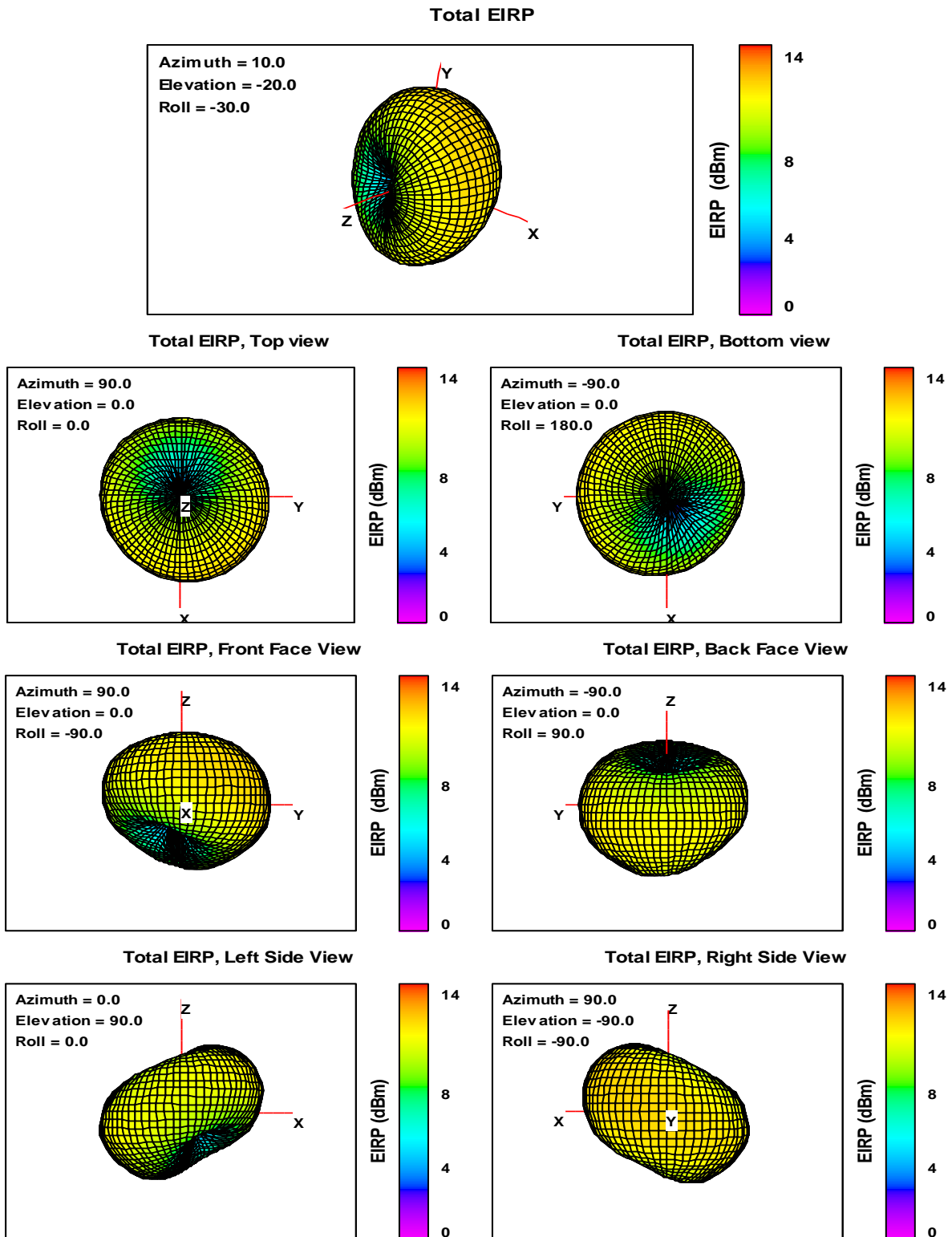

Fig. 27. Total EIRP, Free Space, 869.525 MHz.

6. RANGE REFERENCE MEASUREMENT DATA

Measurement Date:		2020-02-04						
Reference Antenna(s):		ETS Lindgren Dipole antenna 880 MHz, model 3126-880 (Cellular Band)						
Polarization:		Theta (Horizontal)						
Signal Path:		Theta Polarization to Spectrum Analyzer (TRP)						
Band	Freq. (MHz)	Cable Ref. (dBm)	Test Port (dBm)	Noise Floor (dBm)	Test Port - Cable (dB)	Test Port - Noise (dB)	Ref. Ant. Gain (dBi)	Path Loss (dB)
EU 868 MHz	863.1	-	-	-	48.46	-	1.68	50.14
EU 868 MHz	865.1	-	-	-	48.51	-	1.68	50.19
EU 868 MHz	868.3	-	-	-	48.48	-	1.68	50.16
EU 868 MHz	869.5	-	-	-	48.53	-	1.68	50.21

Measurement Date:		2020-02-04						
Reference Antenna(s):		ETS Lindgren Dipole antenna 880 MHz, model 3126-880 (Cellular Band)						
Polarization:		Phi (Vertical)						
Signal Path:		Phi Polarization to Spectrum Analyzer (TRP)						
Band	Freq. (MHz)	Cable Ref. (dBm)	Test Port (dBm)	Noise Floor (dBm)	Test Port - Cable (dB)	Test Port - Noise (dB)	Ref. Ant. Gain (dBi)	Path Loss (dB)
EU 868 MHz	863.1	-	-	-	51.11	-	1.68	52.79
EU 868 MHz	865.1	-	-	-	51.14	-	1.68	52.82
EU 868 MHz	868.3	-	-	-	51.24	-	1.68	52.92
EU 868 MHz	869.5	-	-	-	51.34	-	1.68	53.02

The path loss referenced in the following tables corresponds to the NSA value used in section 2 to determine the EIS level.

Measurement Date:		2020-02-04						
Reference Antenna(s):		ETS Lindgren Dipole antenna 880 MHz, model 3126-880 (Cellular Band)						
Polarization:		Theta (Horizontal)						
Signal Path:		Theta Polarization to Variable Attenuator (TIS)						
Band	Freq. (MHz)	Cable Ref. (dBm)	Test Port (dBm)	Noise Floor (dBm)	Test Port - Cable (dB)	Test Port - Noise (dB)	Ref. Ant. Gain (dBi)	Path Loss (dB)
EU 868 MHz	863.1	-	-	-	48.99	-	1.68	50.67
EU 868 MHz	865.1	-	-	-	49.04	-	1.68	50.72
EU 868 MHz	868.3	-	-	-	49.02	-	1.68	50.70
EU 868 MHz	869.525	-	-	-	49.07	-	1.68	50.75

Measurement Date:		2020-02-04						
Reference Antenna(s):		ETS Lindgren Dipole antenna 880 MHz, model 3126-880 (Cellular Band)						
Polarization:		Phi (Vertical)						
Signal Path:		Phi Polarization to Variable Attenuator (TIS)						
Band	Freq. (MHz)	Cable Ref. (dBm)	Test Port (dBm)	Noise Floor (dBm)	Test Port - Cable (dB)	Test Port - Noise (dB)	Ref. Ant. Gain (dBi)	Path Loss (dB)
EU 868 MHz	863.1	-	-	-	51.61	-	1.68	53.29
EU 868 MHz	865.1	-	-	-	51.69	-	1.68	53.37
EU 868 MHz	868.3	-	-	-	51.80	-	1.68	53.48
EU 868 MHz	869.525	-	-	-	51.87	-	1.68	53.55

Appendix B: Photographs

Equipment under test:

- EUT front view:



Fig 28. EUT front view.

- EUT back view:



Fig 29. EUT back view.

Test set:

- **Free Space set-up without antifreezing case: Initial position: Theta = 0°, Phi = 0°**

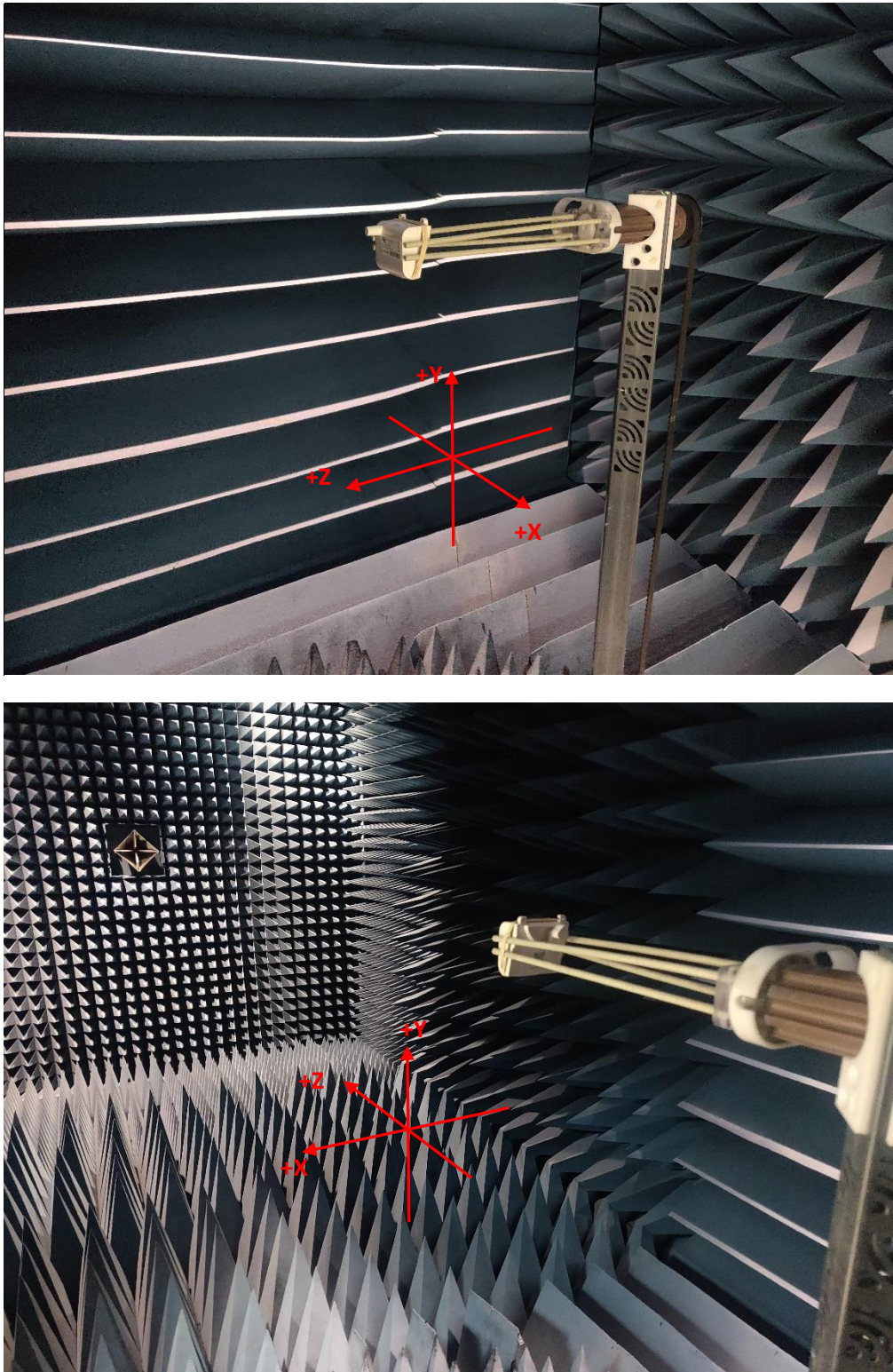

Fig 30. Free Space configuration set-up view.