



Temperature & Humidity Sensor

EM320-TH

User Guide

Contents

Chapter 1. Preface	4
Chapter 2. Product Introduction	6
Overview.....	6
Features.....	6
Chapter 3. Hardware Introduction	7
Packing List.....	7
Hardware Overview.....	7
Dimensions(mm).....	7
Power Button.....	8
Chapter 4. Quick Start	9
Access the Sensor via NFC.....	9
Configure the Network Setting.....	10
Chapter 5. Operation Guide	12
LoRaWAN® Settings.....	12
Time Synchronization.....	14
General Setting.....	15
Calibration Setting.....	18
Threshold Setting.....	18
Maintenance.....	18
Upgrade.....	18
Backup and Restore.....	19
Reset to Factory Default.....	22
Chapter 6. Installation	24
Standard Version.....	24
Magnetic Version.....	25
Chapter 7. Battery Replacing	26
Chapter 8. Uplink and Downlink	27

Overview.....	27
Uplink Data.....	27
Basic Information.....	27
Periodic Report.....	28
Alarm Report.....	28
Historical Data.....	29
Downlink Command.....	29
General Setting.....	29
Temperature Threshold Setting.....	30
Historical Data Enquiry.....	31
Chapter 9. Services.....	33

Chapter 1. Preface

Copyright Statement

This guide may not be reproduced in any form or by any means to create any derivative such as translation, transformation, or adaptation without the prior written permission of Xiamen Milesight IoT Co., Ltd (Hereinafter referred to as Milesight).

Milesight reserves the right to change this guide and the specifications without prior notice. The latest specifications and user documentation for all Milesight products are available on our official website <http://www.milesight.com>

Safety Instruction

These instructions are intended to ensure that user can use the product correctly to avoid danger or property loss. Milesight will not shoulder responsibility for any loss or damage resulting from not following the instructions of this operating guide.



CAUTION:

Injury or equipment damage may be caused if any of these cautions are neglected.

- The device must not be disassembled or remodeled in any way.
- In order to protect the security of the device, please change device password when first configuration. The default password is 123456.
- Do not place the device close to objects with naked flames.
- Do not place the device where the temperature is below/above the operating range.
- The device is not intended to be used as a reference sensor, and Milesight will not should responsibility for any damage which may result from inaccurate readings.
- The device must never be subjected to shocks or impacts.

Revision History

Release Date	Version	Revision Content
Oct.13, 2022	V1.0	Initial version
Mar.15, 2023	V1.1	1. Add single channel mode 2. Add magnetic NFC configuration note

Release Date	Version	Revision Content
June 1, 2023	V1.2	Add pole mounting plate and installation

Chapter 2. Product Introduction

Overview

EM320-TH is a simple, compact and powerful LoRaWAN[®] temperature & humidity sensor. It is equipped with high-precision sensors and IP67 waterproof design, applicable for accurate temperature and humidity data detection in various harsh environments. FDA-approved food-grade material's enclosure and magnet design allow it to be placed in freezers and refrigerators and in contact with food or medicines safely. Two optional versions can unleash the potential of EM320-TH sensor to the maximum.

In addition to LoRaWAN[®] technology with low power consumption, it has built-in high-capacity batteries available for usage for up to 10 years without battery replacement. Moreover, EM320-TH is compatible with both Milesight LoRaWAN[®] Gateway and Milesight Development Platform to achieve remote data monitoring and management. It is suitable for both indoor and outdoor applications such as cold chain transportation, agricultural greenhouse, office buildings, hospitals, factories, etc.

Features

- Uses high-precision sensor, capable of sensor subtle changes in temperature and humidity
- IP67 waterproof enclosure with multi-level structure and sealing ring design enabling strong waterproof performance for harsh environments
- Uses FDA-approved food-grade material's enclosure, which is safe for contact with food or medicines
- Ultra-low power consumption and standby with 5400mAh built-in replaceable batteries, ensuring durable battery life
- Wall mounting or magnet version optional for multiple installation scenarios
- Anti-theft and anti-slip pad design on back cover to secure firm and sturdy installation
- Long range data transmission for up to 15 kilometers in rural areas
- Store locally 3000 historical records and support retransmission to prevent data loss
- Equipped with NFC for easy configuration
- Compliant with standard LoRaWAN[®] gateways and network servers
- Quick and easy management with Milesight IoT Cloud and Milesight Development Platform solution

Chapter 3. Hardware Introduction

Packing List



1 × EM320-TH Device



1 × Quick Guide



1 × Warranty Card

Standard Version Only:

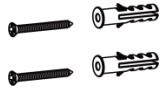

2 × Wall Mounting Kits



1 × Fixing Screw



1 × Pole Mounting Plate



Note:

If any of the above items is missing or damaged, please contact your sales representative.

Hardware Overview

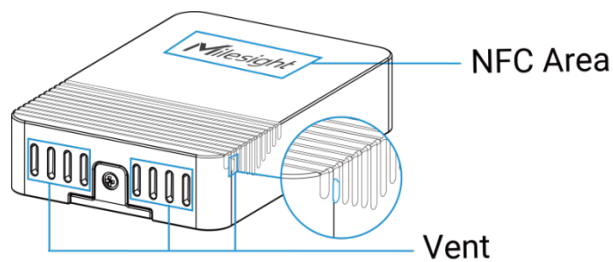

Dimensions(mm)

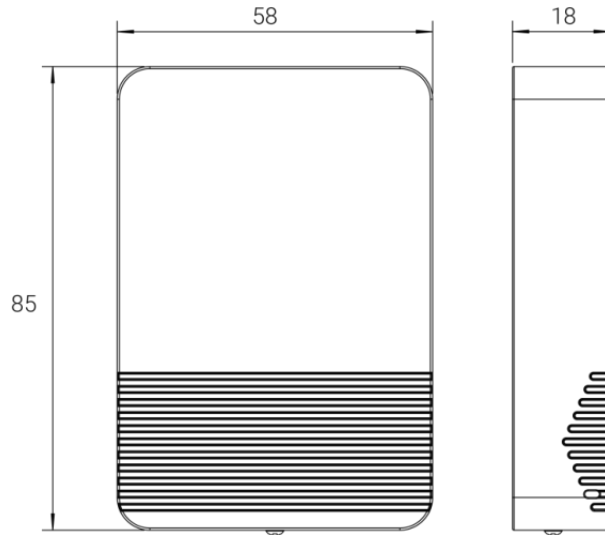

Power Button

There is a LED indicator and a power button inside the device for emergency reboot or reset.

Function	Action	LED Indicator
Power On	Press and hold the button for more than 3 seconds.	Off → On
Power Off		On → Off
Reset to Factory Default	Press and hold the button for more than 10 seconds.	Blinks quickly
Check On/Off Status	Quickly press the power button once.	Light On: device is on.
		Light Off: device is off.

Chapter 4. Quick Start

This chapter describe the steps to quickly configure this device. If you requires more advanced settings, please refer to operation guide chapter.

Access the Sensor via NFC

1. Download and install "Milesight ToolBox" App from Google Play or Apple Store on an NFC-supported smartphone.
2. Enable NFC function on the smartphone.
3. Launch Milesight ToolBox, and select the default mode as NFC.
4. Attach the smart phone with NFC area to the device and click  to read device information. Basic information, data, and settings of the device will be shown on the Milesight ToolBox App if it's recognized successfully.
5. Adjust the settings on the App, then attach the smartphone with NFC area to the device and click **Write** to write the settings. After writing, reread the device to check if the configuration is written well.



Note:

- Ensure the location of smartphone NFC area and it's recommended to take off phone case.
- If the smart phone fails to read/write configurations via NFC, keep the phone away and back to try again.
- The default device password is 123456. Please change a new password for security.
- For magnetic version, take away device from magnetic surface and keep the smartphone about 10 mm away from the device NFC area to read it. Click [here](#) for more guidance or reach out Milesight technical support team.

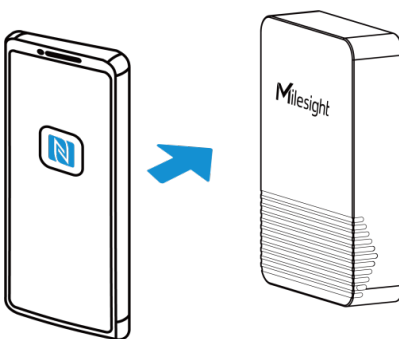

Configure the Network Setting

1. Go to **Network** settings page, select the join type as OTAA or ABP as required.



Note:

OTAA mode is required if you connect device to Milesight IoT Cloud or Milesight Development Platform.

2. Select supported frequency the same as LoRaWAN[®] gateway.



Note:

Set the channel index as 8-15 for US915 or AU915 if using default settings of Milesight gateways.

Device

Network

LoRaWAN

* Support Frequency

US915 ▼

Enable Channel Index ⓘ

8-15



Index	Frequency/MHz ⓘ
0 - 15	902.3 - 905.3
16 - 31	905.5 - 908.5
32 - 47	908.7 - 911.7
48 - 63	911.9 - 914.9
64 - 71	903 - 914.2

3. Keep other settings by default and click **Write** to save the settings.

Chapter 5. Operation Guide

LoRaWAN[®] Settings

This chapter describes the LoRaWAN[®] network settings of device.

Parameter	Description
Device EUI	<p>Unique ID of the device which can be found on the device.</p> <div style="border: 1px solid #ccc; background-color: #e6f2ff; padding: 10px; margin-top: 10px;">  Note: please contact sales for device EUI list if you have many units. </div>
App EUI	The default App EUI (join EUI) is 24E124C0002A0001.
Application Port	The port used for sending and receiving data, the default port is 85.
LoRaWAN [®] Version	V1.0.2 and V1.0.3 are available.
Work Mode	It's fixed as Class A.
Confirmed Mode	If the device does not receive ACK packet from network server, it will re-send data once.
Join Type	<p>OTAA and ABP mode are available.</p> <div style="border: 1px solid #ccc; background-color: #e6f2ff; padding: 10px; margin-top: 10px;">  Note: it's necessary to select OTAA mode if connecting device to Milesight IoT Cloud or Milesight Development Platform. </div>
Application Key	<p>Appkey for OTAA mode, default value: "Device EUI" + "Device EUI" (since Q4 of 2025). Example: 24e124123456789024e1241234567890</p> <div style="border: 1px solid #ccc; background-color: #e6f2ff; padding: 10px; margin-top: 10px;">  Note: <ul style="list-style-type: none"> The default value of earlier devices is 5572404C696E6B4C6F52613230313823. Please contact sales before purchase if you require random App Keys. </div>

Parameter	Description
Network Session Key	Nwkskey for ABP mode, the default is 5572404C696E6B4C6F52613230313823.
Application Session Key	Appskey for ABP mode, the default is 5572404C696E6B4C6F52613230313823.
Device Address	DevAddr for ABP mode, default is the 5 th to 12 th digits of SN.
Rejoin Mode	<p>Reporting interval ≤ 35 mins: the device will send a specific number of Link-CheckReq MAC packets to the network server every reporting interval or every double reporting interval to validate connectivity; If there is no response, the device will re-join the network.</p> <p>Reporting interval > 35 mins: the device will send a specific number of LinkCheckReq MAC packets to the network server every reporting interval to validate connectivity; If there is no response, the device will re-join the network.</p> <div data-bbox="526 949 1393 1239" style="background-color: #e6f2ff; padding: 10px; border-radius: 5px;"> <p> Note:</p> <ol style="list-style-type: none"> 1. Only OTAA mode supports rejoin mode. 2. The actual sending number is Set the number of packets sent +1. </div>
Channel Mode	Select Standard-Channel mode or Single-Channel mode. When Single-Channel mode is enabled, only one channel can be selected to send uplinks.
Supported Frequency	<p>Enable or disable the frequency to send uplinks. If frequency is one of CN470/AU915/US915, enter the index of the channel to enable in the input box, making them separated by commas.</p> <p>Examples:</p> <p>1, 40: Enabling Channel 1 and Channel 40</p> <p>1-40: Enabling Channel 1 to Channel 40</p> <p>1-40, 60: Enabling Channel 1 to Channel 40 and Channel 60</p> <p>All: Enabling all channels</p>

Parameter	Description
	Null: Indicate that all channels are disabled
ADR Mode	Enable or disable network server to adjust Spreading Factor, Bandwidth and Tx Power to optimize data rates, airtime and energy consumption in the network.
Spreading Factor	If ADR mode is disabled, the device will send uplink data following this SF parameter. The higher the spreading factor, the longer the transmission distance, the slower the transmission speed and the more the consumption.
Tx Power	Tx power (transmit power) refers to the strength of the outgoing signal transmitted by the device. This is defined by LoRa alliance.
RX2 Data Rate	RX2 data rate to receive downlinks.
RX2 Frequency	RX2 frequency to receive downlinks. Unit: Hz

Time Synchronization

This section describes how to sync the time of the device.

Sync via ToolBox App

After reading the device via Milesight ToolBox App, sync the device time with time zone from the smart phone.

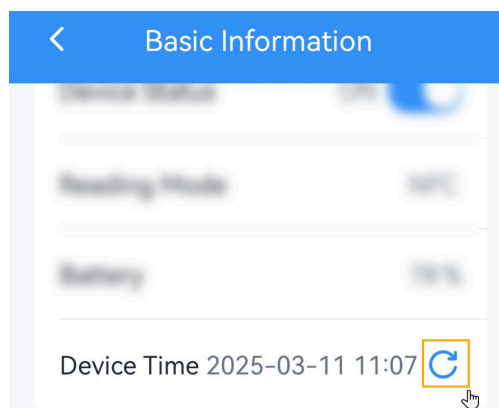
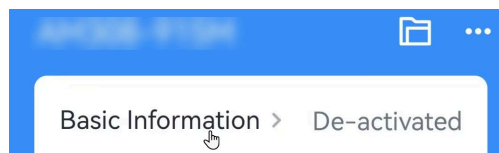

Sync via Network Server

This requires to ensure the LoRaWAN[®] network server supports device time synchronization feature. Example: Milesight gateway embedded NS.

1. Set the LoRaWAN[®] version of the device to V1.0.3.
2. Connect the device to the network server. After joining the network, the device will send a DeviceTimeReq MAC command to enquire the time from network server.



Note:

- This only supports to get the time but not time zone. The time zone can be configured by ToolBox App or downlink command.
- The device will send the DeviceTimeReq command every 5 days since the last sync.

General Setting

General settings include the basic parameters of the device.

Temperature Unit (i)

°C

Reporting Interval - 10 + min



Data Storage (i)

Data Retransmission (i)

Change Password

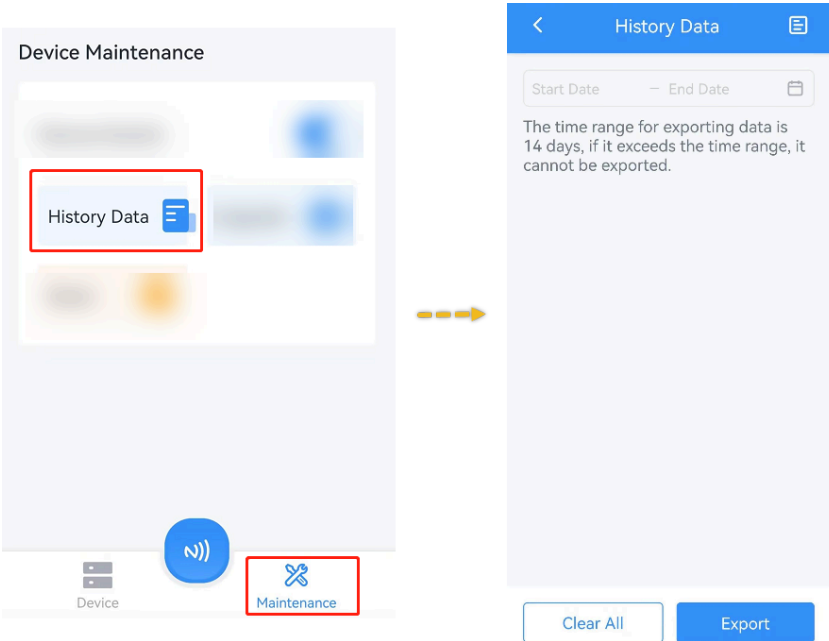
Parameter	Description
Temperature Unit	Change the temperature displayed on the ToolBox.

Parameter	Description
	<p> Note:</p> <ol style="list-style-type: none"> 1. The temperature unit in the reporting package is fixed as Celsius(°C). 2. Please modify the threshold settings if the unit is changed.
Reporting Interval	The interval to report current data to network server. Range: 1-1080 minutes, Default: 10 minutes.
Data Storage	<p>Disable or enable to store periodic report data locally. The stored data can be exported as CSV format file and saved to smartphone via Tool-Box.</p>  <p>The image shows two screenshots from a mobile application. The left screenshot is titled 'Device Maintenance' and shows a list of options: 'Device', 'Maintenance', and 'History Data'. The 'History Data' option is highlighted with a red rectangular box. Below the list are icons for 'Device' and 'Maintenance'. A dashed yellow arrow points from the 'History Data' option to the right screenshot. The right screenshot is titled 'History Data' and shows a date range selector with 'Start Date' and 'End Date' fields. Below the selector, it states: 'The time range for exporting data is 14 days, if it exceeds the time range, it cannot be exported.' At the bottom of this screen are two buttons: 'Clear All' and 'Export'.</p>

Parameter	Description
	<div data-bbox="560 262 1393 688" style="background-color: #e6f2ff; padding: 10px;">  Note: <ol style="list-style-type: none"> 1. It is necessary to sync the time to ensure the data is stored in correct time. 2. The device will still store the data even the network status is de-activated. 3. ToolBox App can only export the last 14 days' data at most. </div>
Data Retransmission	<p>Disable or enable data retransmission. When the device detects the network status is de-activated via Rejoin Mode, the device will record a data lost time point and re-transmit the lost data after device re-connects to the network.</p> <div data-bbox="560 913 1393 1696" style="background-color: #e6f2ff; padding: 10px;">  Note: <ol style="list-style-type: none"> 1. This setting only takes effect when Data Storage is enabled. 2. If the device is rebooted or re-power when data retransmission is not completed, the device will re-send all retransmission data again after device is reconnected to the network. 3. If the network is disconnected again during data retransmission, it will only send the latest disconnected data. 4. The default report data retransmission interval is 600s, this can be changed via downlink command. 5. The reported format of retransmission data will include timestamps and is different from periodic report data. 6. This setting will increase the uplink frequencies and shorten the battery life. </div>
Change Password	Change the device password for ToolBox App to write this device.

Calibration Setting

The device supports to add the calibration value to the raw collected value, and report the results.

Temperature

Numerical Calibration

Current Value: 29.5 °C

Calibration Value

°C

Final Value: 29.5 °C

Humidity

Threshold Setting

When current value is over or below the threshold value, the device will report a threshold alarm packet once instantly. Only when the threshold alarm is dismissed and re-triggered, the device will send the threshold alarm again.

Temperature

Over / °C

Below / °C

Collecting Interval 10 min

Parameter	Description
Collect Interval	The interval to detect temperature after threshold alarm triggers. This interval should be less than reporting interval.

Maintenance

Upgrade

This chapter describes the steps to upgrade the device via ToolBox App.

1. Download firmware from Milesight official website to your smartphone.
2. Read the target device via ToolBox App, click **Upgrade** to upload the firmware file.
3. Click **Upgrade** to upgrade the device.

**Note:**

- Operation on ToolBox is not supported during an upgrade.
- Only Android version ToolBox supports the upgrade feature.

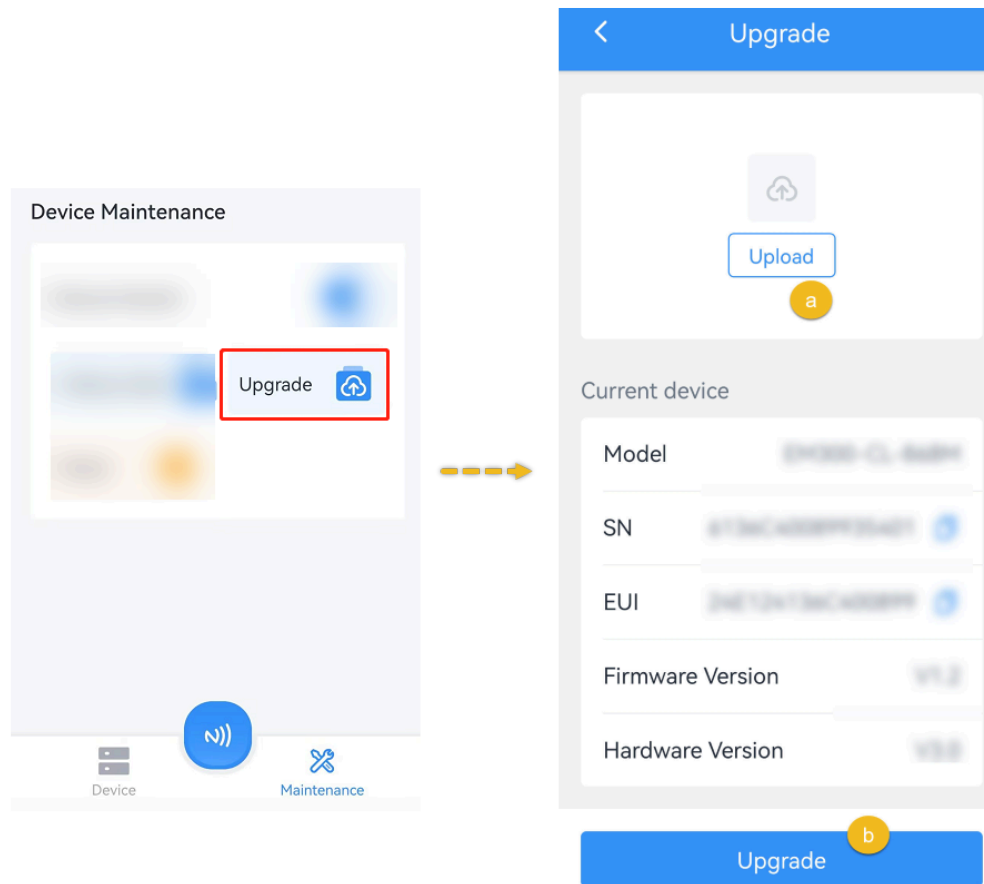

Backup and Restore

This device supports configuration backup for easy and quick device configuration in bulks. Backup and restore is allowed only for devices with the same model and frequency band.

Backup and Restore

Step 1: Launch ToolBox App, attach the NFC area of smartphone to the device to read the configuration.

Step 2: Edit the configuration as required, click **Set Template** to save current configuration as a template to the ToolBox App.

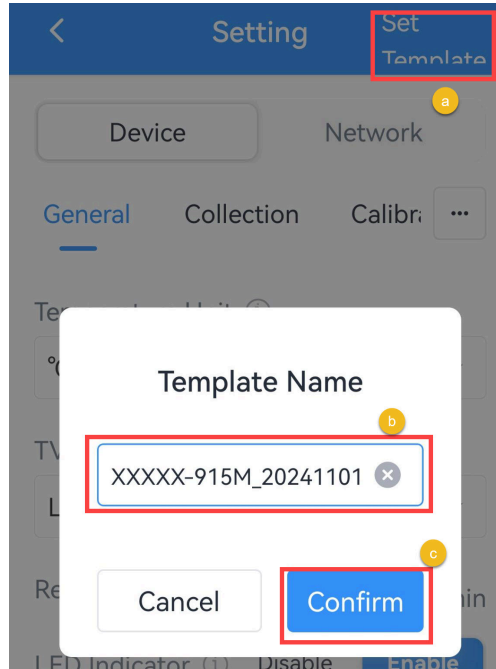

Step 3: Go to **Device >Template** page.



Step 4: Select and click the target template, click **Write** to import the configuration to target devices.

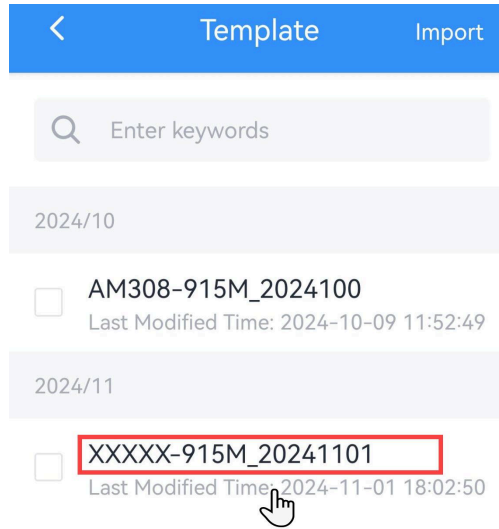

Export and Delete Template

Step 1: Check the box of the target template.

Step 2: Click **Export** to export this template as JSON format file and save it to the smartphone, click **Delete** to delete this template from your ToolBox App.

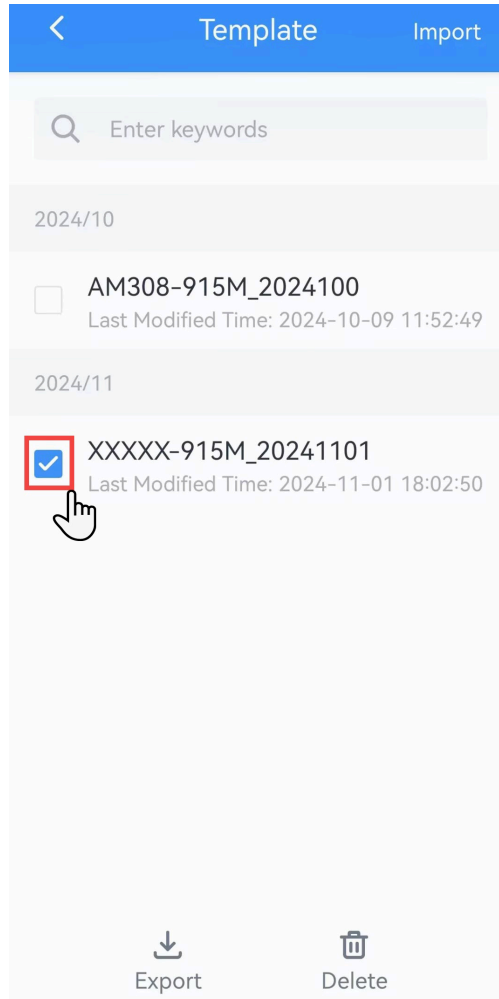

Reset to Factory Default

Via Hardware: Hold on the reset button for more than 10s until the LED indicator quickly blinks.

Via ToolBox App: Click **Reset** and attach the smartphone to device to reset the device.

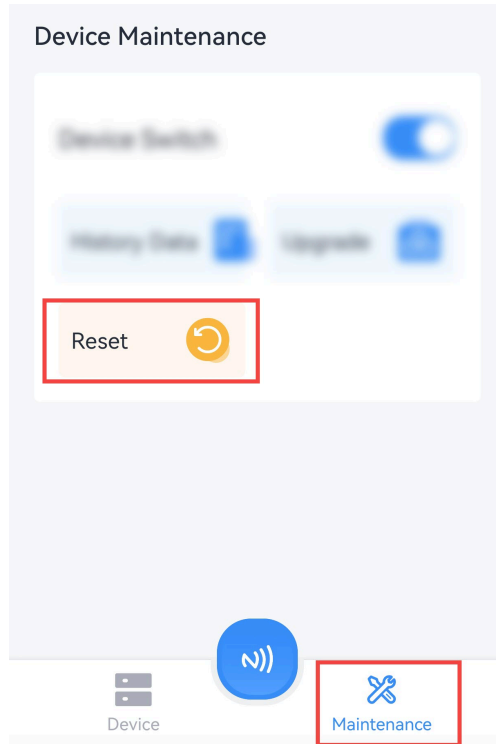

Chapter 6. Installation

Standard Version

EM320-TH standard version supports wall mounting or pole mounting.

Wall Mounting

1. Remove the backplate on the back of the device, screw the wall plugs into the wall and fix the backplate with screws on it, then install back the device. Note that the vent of device should not face upwards when installing.

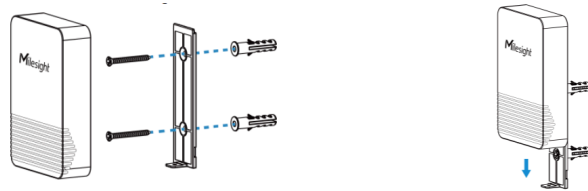

2. Fix the bottom of the device to the cover with a fixing screw.



Pole Mounting

Switch the backplate on the back of the device to the pole mounting plate and fix the plate with a screw, then pass a cable tie through the plate and wrap it with device to the pole.

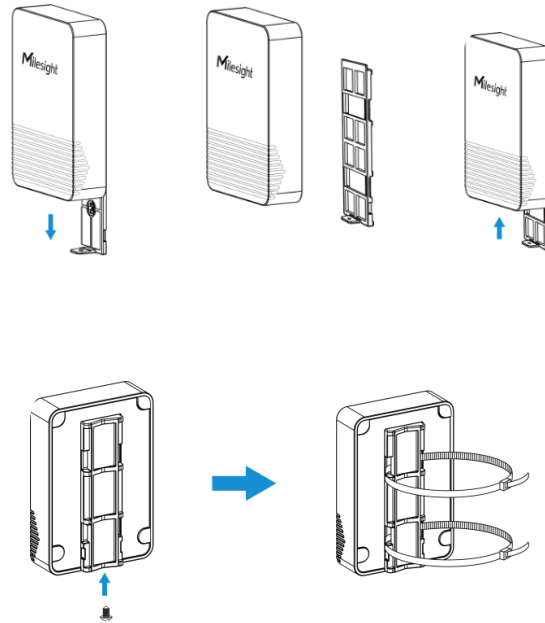

Magnetic Version

Attach the device to a magnetic surface such as the metal surface of the refrigerator, freezer, freight container, etc. The back of the device is equipped with anti-slip pad to secure firm and sturdy installation. Note that the vent should not face upwards.

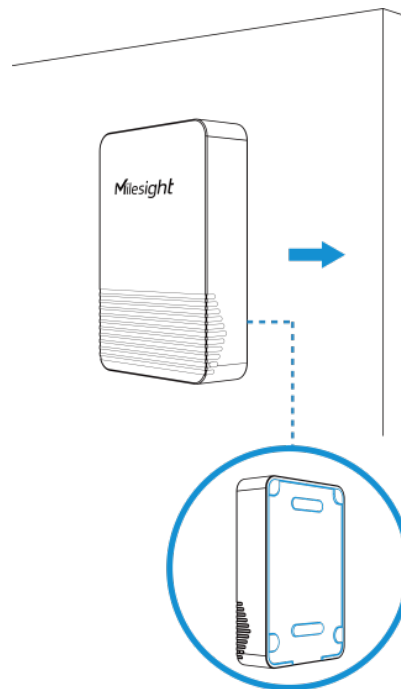

Chapter 7. Battery Replacing

When the batteries have run out of power, please release the screws behind the rubber feet, and then remove the back cover to replace the new batteries.

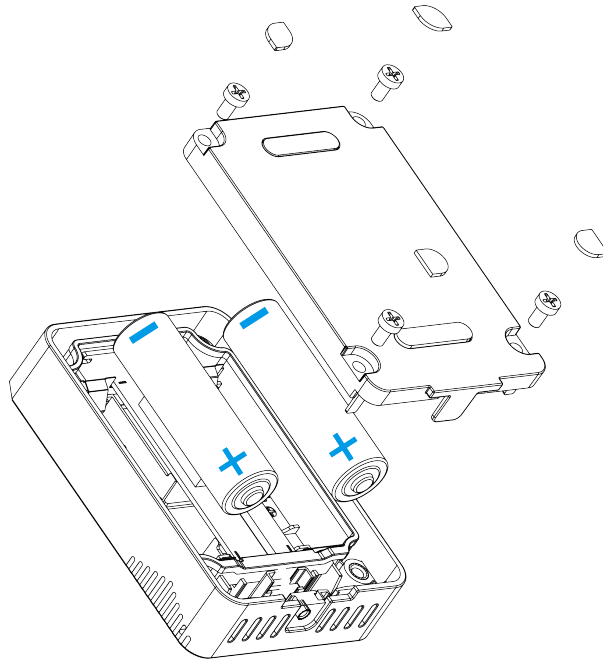

Note:

- The device can only be powered by the ER14505 Li-SOCl₂ batteries. The alkaline battery is not supported.
- The battery should be removed from the device if it is not to be used for an extended period. Otherwise, the battery might leak and damage the device. Never leave a discharged battery in the battery compartment.
- Ensure all replacing batteries are newest; otherwise, it may shorten battery life or cause inaccurate power calculations.

Chapter 8. Uplink and Downlink

Overview

All messages are based on following format (HEX), the Data field should follow little-endian:

Channel1	Type1	Data1	Channel2	Type2	Data2	Channel3	...
1 Byte	1 Byte	N Bytes	1 Byte	1 Byte	N Bytes	1 Byte	...

For decoder examples please find files on <https://github.com/Milesight-IoT/SensorDecoders>.

Uplink Data

This chapter describes the reported data of the device.

Item	Channel	Type	Byte	Description
Power On	ff	0b	1	Device is on
Protocol Version	ff	01	1	Example: 01=V1
Hardware Version	ff	09	2	Example: 03 10 = V3.1
Software Version	ff	0a	2	Example: 03 01 = V3.1
Device Type	ff	0f	1	00: Class A, 01: Class B, 02: Class C, 03: Class C to B
Serial Number	ff	16	8	16 digits
Battery Level	01	75	1	UINT8, Unit: %
Temperature	03	67	2	INT16, Unit: °C, Resolution: 0.1 °C
Humidity	04	68	1	UINT8, Unit: %RH, Resolution: 0.5 %RH
Historical Data	20	ce	7	Byte 1-4: Data unix timestamp, UINT32, Unit: s Byte 5-6: Temperature, INT16/10, Unit: °C Byte 7: Humidity, UINT8/2, Unit: %RH

Basic Information

The device will report a basic information packet whenever joining the network.

Example:

ff166785c38226020003 ff090110ff0a0101ff0f00		
Channel	Type	Value
ff	0b	ff
ff	01	01=V1
ff	16	6785c38226020003
ff	09	0110=V1.1
ff	0a	0101=V1.1
ff	0f	00: Class A

Periodic Report

The device supports to report sensor data according to reporting interval (10mins by default).

Example:

017564 03672201 046850		
Channel	Type	Value
01	75	Battery: 64=>100%
03	67	Temperature: 22 01=> 01 22 = 290/10=29°C
04	68	Humidity: 50 => 80/2=40 %RH

Alarm Report

The device supports to report below types of alarm report packets.

1. Temperature threshold alarm: report when threshold alarm is triggered.

03671001		
Channel	Type	Value
03	67	Temperature: 1001=> 0110 = 272/10=27.2°C

2. Low battery level alarm: report when the battery level drops to 1%.

017501		
Channel	Type	Value
01	75	01=1%

Historical Data

The device will report retransmission data or stored data as below example.

20ce 0d755b63 10015d			
Channel	Type	Time Stamp	Value
20	ce	0d 75 5b 63 => 63 5b 75 0d=1666938125s	Temperature: 1001=>0110=27.2°C Humidity: 5d=>93/2=46.5%

Downlink Command

This device supports downlink commands for configuration and control. The downlink application port is 85 by default.

General Setting

Item	Channel	Type	Byte	Description
Reboot	ff	10	1	ff
Collect Interval	ff	02	2	UINT16, Unit: s
Report Interval	ff	03	2	UINT16, Unit: s
Data Storage	ff	68	1	00: Disable, 01: Enable
Data Retransmission	ff	69	1	00: Disable, 01: Enable
Data Retransmission Interval	ff	6a	3	Byte 1: 00 Byte 2-3: UINT16, Unit: s, Range: 30~1200, Default: 600

Example:

1. Reboot the device.

ff10ff

2. Set collect interval as 20 minutes.

ff02b004		
Channel	Type	Value
ff	02	b004=>04b0=1200s=20 minutes

3. Set the data retransmission interval as 1200s.

ff6ab004		
Channel	Type	Value
ff	6a	b004=>04b0=1200s

Temperature Threshold Setting

Channel	Type	Byte	Description
ff	06	9	<p>Byte 1: c8=Disable, c9=Below (min. threshold), ca=Over (max. threshold), cb=Within, cc=Below or over</p> <p>Byte 2-3: Minimum threshold, INT16/10, Unit: °C</p> <p>Byte 4-5: Maximum threshold, INT16/10, Unit: °C</p> <p>Byte 6-9: 00000000</p>

Example:

When temperature is below 20°C or over 30°C, it will upload current value immediately.

ff06cc c8002c0100000000		
Channel	Type	Value
ff	06	<p>cc=>11001 100100=> below or over</p> <p>Min. threshold: c8 00=>00 c8=200/10=20°C</p> <p>Max. threshold: 2c 01 => 01 2c =300/10=30°C</p>

Historical Data Enquiry

The device supports data retrievability feature to send downlink command to enquire the historical data stored in the device. Before that, ensure the device time is correct and data storage feature was enabled to store data.

Command Format:

Item	Channel	Type	Byte	Description
Enquire Data in Time Point	fd	6b	4	Unix timestamp, Unit: s
Enquire Data in Time Range	fd	6c	8	Byte 1-4: Start timestamp, Unit: s Byte 5-8: End timestamp, Unit: s
Stop Query Data Report	fd	6d	1	ff
Data Retrieval Interval	ff	6a	3	Byte 1: 01 Byte 2-3: UINT16, Unit: s, Range: 30~1200, Default: 60

Reply Format:

Item	Channel	Type	Byte	Description
Enquiry Result	fc	6b/6c	1	00: Enquiry success. The device will report the historical data according to data retrievability interval. 01: Time point or time range invalid 02: No data in this time or time range



Note:

1. Use [Unix Timestamp Converter](#) to calculate the time.
2. The device only uploads no more than 300 data records per range enquiry.
3. When enquiring the data in time point, it will upload the data which is closest to the search point within the reporting interval range. For example, if the device's reporting interval is 10



minutes and users send command to search for 17:00's data, if the device find there is data stored in 17:00, it will upload this data; if not, it will search for data between 16:50 to 17:10 and upload the data which is closest to 17:00.

Example:

Enquire the historical data in a time range.

fd6c 64735b63 7c885b63		
Channel	Type	Value
fd	6c	Start time: 64 73 5b 63 => 63 5b 73 64 = 1666937700s End time: 7c 88 5b 63 => 63 5b 88 7c = 1666943100s

Reply:

fc6c00		
Channel	Type	Value
fc	6c	00: Enquiry success

20ce 0d755b63 10015d			
Channel	Type	Time Stamp	Value
20	ce	0d 75 5b 63 => 63 5b 75 0d=1666938125s	Temperature: 1001=>0110=27.2°C Humidity: 5d=>93/2=46.5%

Chapter 9. Services

Milesight provides customers with timely and comprehensive technical support services. End-users can contact your local dealer to obtain technical support. Distributors and resellers can contact directly with Milesight for technical support.

Technical Support Mailbox: iot.support@milesight.com

Online Support Portal: <https://support.milesight-iot.com>

Resource Download Center: <https://www.milesight.com/iot/resources/download-center/>

MILESIGHT CHINA

TEL: +86-592-5085280

FAX: +86-592-5023065

Add: Building C09, Software Park Phase III, Xiamen 361024, Fujian, China